

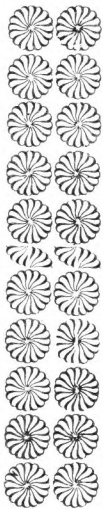

REPRINTS  
FROM OUR  
1901  
CATALOGUE



...PARTIAL LIST OF...

# *Physiological and Psychological Apparatus*

*Manufactured by*

**THE CHICAGO  
LABORATORY  
SUPPLY AND  
SCALE CO.**

*Manufacturers  
and Importers of*

*Scientific Apparatus.*



39 W. Randolph Street,  
CHICAGO, ILL.

## PHYSIOLOGICAL AND PSYCHOLOGICAL APPARATUS.

7000. **Kymograph**, complete with 100 sheets of Gummed Glazed Paper ..... *Net*, \$35.00

This new Kymograph, originally designed for and used in the Physiological and Psychological Laboratories of the University of Chicago, for making index tracings upon smoked paper, has met with such a flattering reception from numerous other laboratories, that we feel justified in claiming for it that it meets all the requirements exacted of such an instrument, notwithstanding the fact that its price is exceedingly low.

The Kymograph is 55 cm. high, with a base 20 x 28 cm. Its weight is 15 kilogrammes, thus insuring sufficient firmness against lateral vibrations. It consists of an accurately turned brass cylinder 12.5 cm. in length by 15 cm. in diameter, which is supported by a steel shaft revolving on hardened steel pivots. This cylinder can be easily removed or adjusted vertically by the set screw at the end. It is rotated by a strong spring motor enclosed in the heavy iron base. The speed is uniform and can be regulated by the use of small fans, as shown in the illustration, which are slipped over an upright pinion. Three fans are supplied with each instrument. The largest permits the cylinder to make one revolution in ten minutes, the medium one in five minutes, the smallest one in one minute, while the clockwork running without any fan revolves the cylinder once in ten seconds. Any desired speed can be obtained by trimming the ends of the fans as much as may be found necessary. The clockwork is started or stopped by the small button near the base of case as shown in the illustration. An adjustable leg provided at the upper end of the arm, which supports the drum, permits the Kymograph to be used in a horizontal position as shown above.

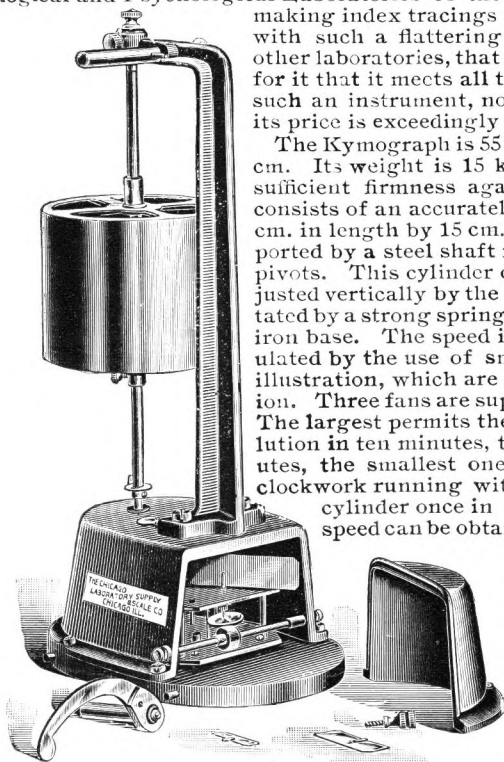

7000.

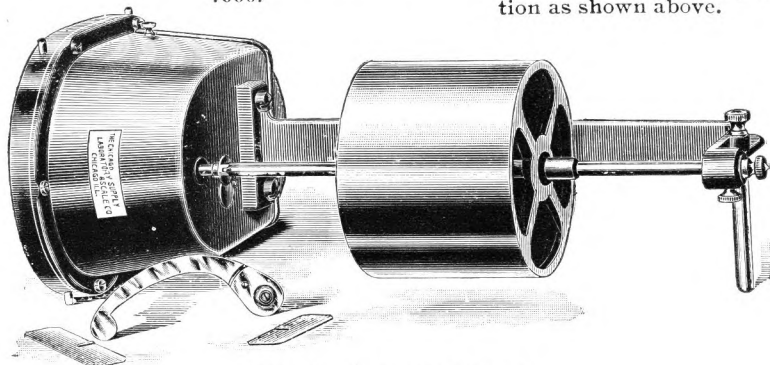

7000. In Horizontal Position.

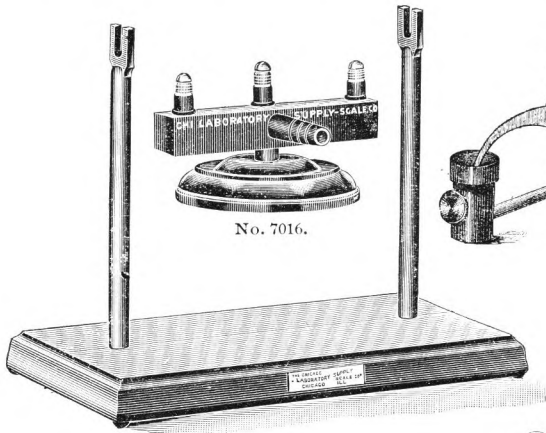

No. 7016.

No. 7014

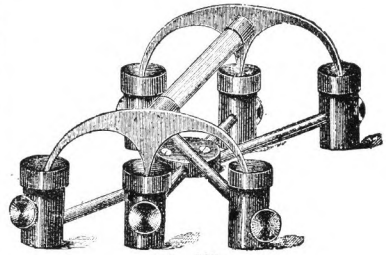

No. 7020.

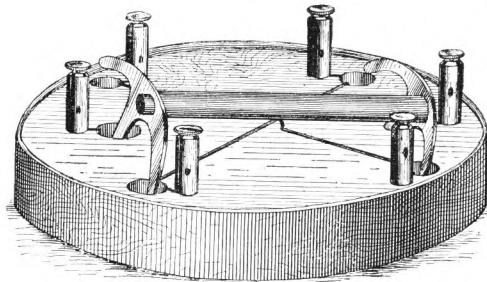

No. 7028.

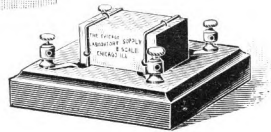

No. 7030.

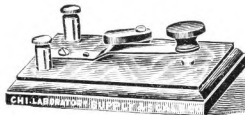

No. 7020.

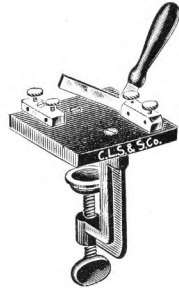

No. 7018.

7002.	Glazed Paper, gummed, for regular drum..per 100 sheets, net,	\$1.00
7004.	“ “ “ “ 11 inch “ .. “ 100 “ “	2.00
7006.	Extra Brass Drum, with shaft, regular size.....	7.50
7008.	“ “ “ “ 11 inch long.....	10.00
7010.	Steel Stylus, for use with writing levers.....	.50
7012.	Aluminum Holder for same.....	.50
7014.	Support for Drum while blackening paper.....	2.00
7016.	Gas Burner for blackening paper.....	1.00
7018.	Key, DuBois Reymond.....	3.00
7020.	“ simple, with platinum point.....	1.25
7022.	Rheocord, Oxford (Hall).....	4.00
7024.	“ Du Bois Reymond.....	25.00
7026.	Mercury Commutator, Ludwig's.....	6.50
7028.	“ “ Pohl's.....	2.25
7030.	Pole Changer, mercury contacts.....	.75

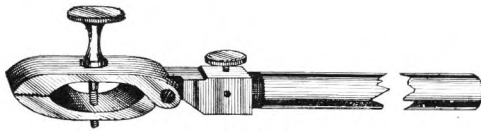

No. 7032.



No. 7040.

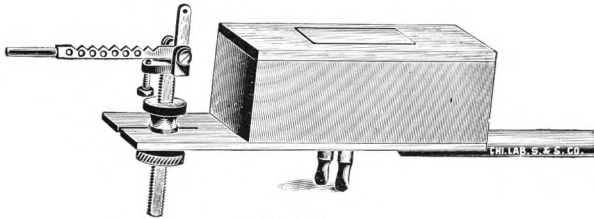

No. 7036.



No. 7044.

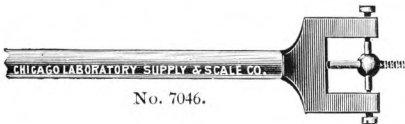

No. 7046.

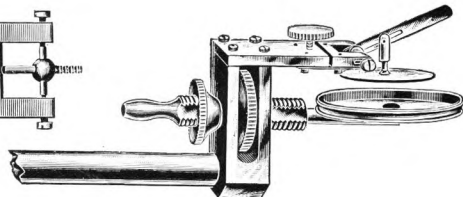

No. 7052.

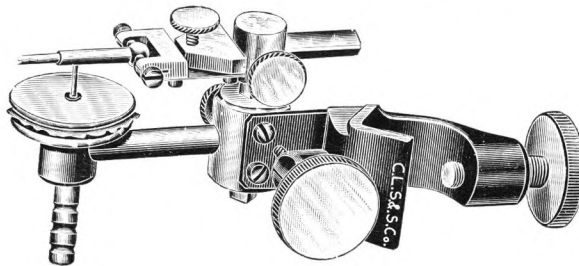

No. 7050.

7032.	Muscle Forceps.....	net,	\$2.00
7034.	“ “ (Hall).....	“	.75
7036.	Crank Myograph.....	“	5.00
7038.	Muscle Weights.....	“	1.75
7040.	Gas Chamber.....	“	7.50
7042.	Moist Chamber.....	“	15.00
7044.	Cardiograph, Marey's.....	“	4.00
7046.	Heart or Muscle Lever.....	“	1.75
7048.	Mercury Manometer.....	“	15.50
7050.	“ “ Tambour.....	“	8.50
7052.	Tambour, Marey's.....	“	6.50
7054.	“ Pans, simple.....	each,	.75
7056.	Sheet Rubber for tambour pans.....	per square foot,	.25
7058.	Piston Recorder, (Lombard & Pillsbury).....	“	12.00

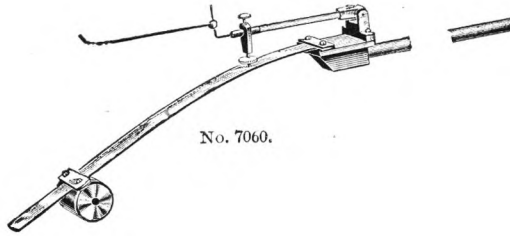

No. 7060.

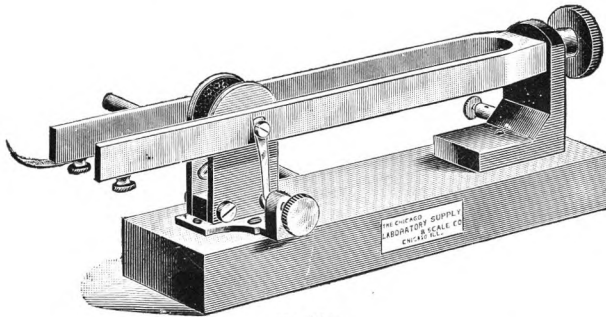

No. 7064.

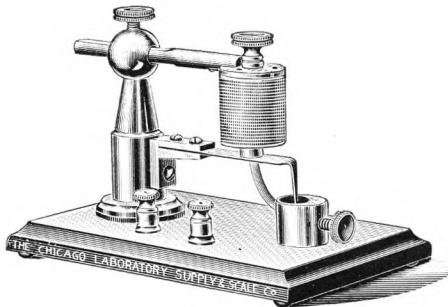

No. 7066.

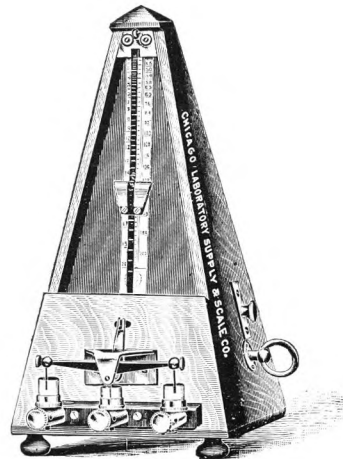

No. 7068.

- 7060. **Time Marker**, after Prof. V. Basch, consisting of a vibrating reed; vibrates about three minutes, marking  $\frac{1}{2}$  seconds, net ..... \$ 7.50
- 7062. **Tuning Fork, Electric**, 50 vibrations .....net, 20.00
- 7064. " " " 100 " ..... " 20.00
- 7066. **Vibrating Reed, Electric (Reichert's)** ..... " 17.50
- 7068. **Metronome**, with mercury cup after Kronecker ..... " 10.00
- 7069. " for exciting, making contact every 2nd, 3d, 4th or 6th stroke of the pendulum.....net, 13.50

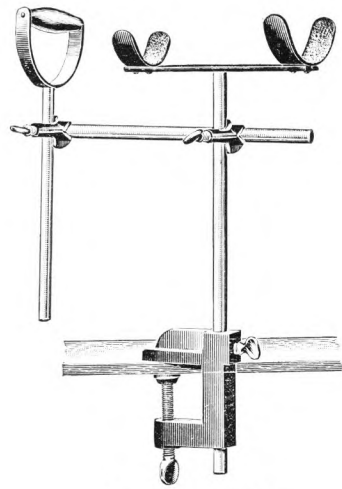
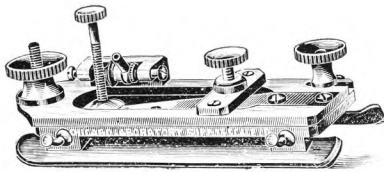
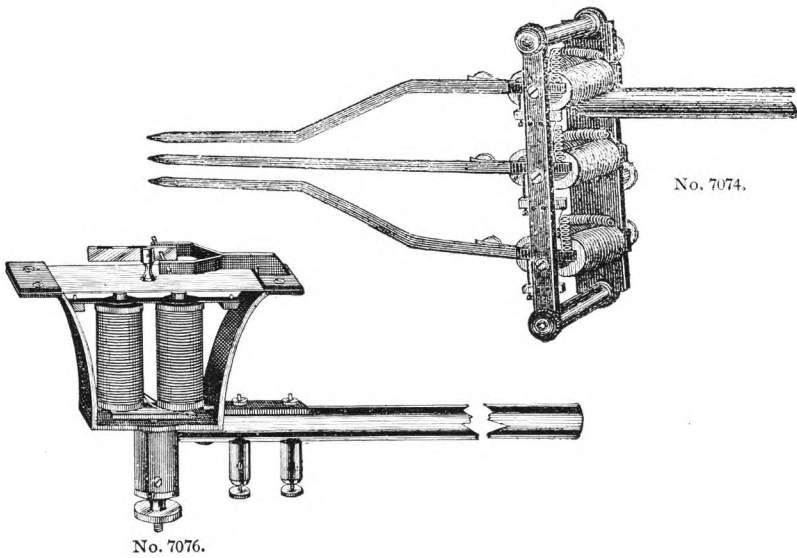

7070.	Time Marker, Electric, single.....	net, \$ 7.50
7072.	“ “ “ double.....	“ 15.00
7074.	“ “ “ triple.....	“ 20.00
7076.	“ “ “ single, after Pfeil.....	“ 7.50
7078.	Sphygmograph, Dudgeon's.....	“ 13.00
7080.	“ after Ludwig, with arm support.....	“ 20.00
7084.	Electrode, non-polarizing, clay point, each, 50c; per doz..	“ 5.00
7086.	“ “ “ brush “ “ 50c; “ ..	“ 5.00
7088.	“ platinum, shielded.....	“ 2.50

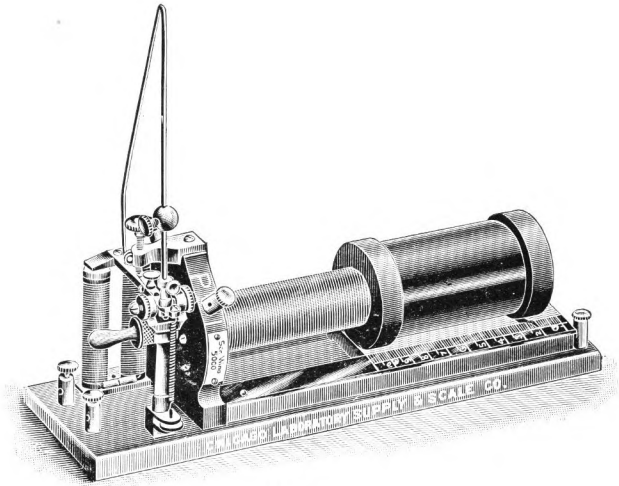

No. 7090.

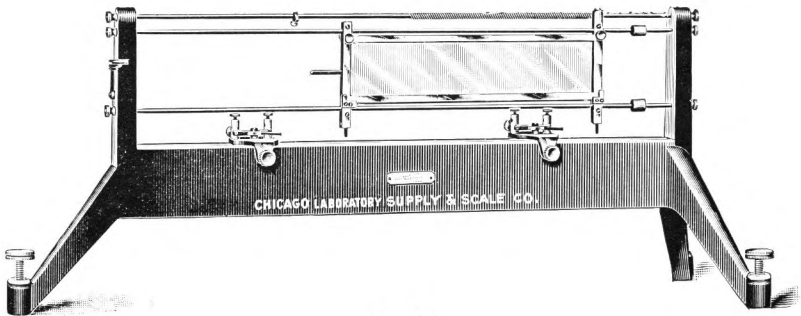

No. 7094.

- |       |  |              |
|-------|--|--------------|
| 7090. | Induction Coil, Du Bois Reymond, with adjustable interrupter, new form with scale 20 c. m. long..... | net, \$17.50 |
| 7092. | Induction Coil, Du Bois Reymond, vertical form, scale 45 c. m. long.....                             | net, 35.00   |
| 7094. | Spring Myograph (Lingle).....  | “ 40.00      |
| 7096. | Copper Spirometer.....   | “ 20.00      |
| 7098. | Chest Pantograph (see Hall Text Book of Physiology, 203)..   | “ 7.50       |
| 7100. | Chest Calipers.....  | “ 3.00       |
| 7102. | Pneumograph, after P. Burt.....  | “ 2.50       |
| 7104. | Plethysmograph, Roy's.....   | “ 6.50       |
| 7106. | “ Mosso's...all glass.....   | “ 10.00      |

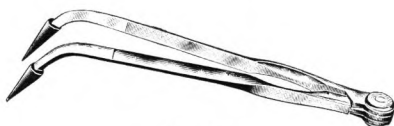

No. 7300.

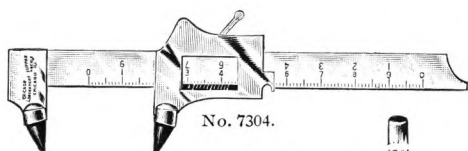

No. 7304.

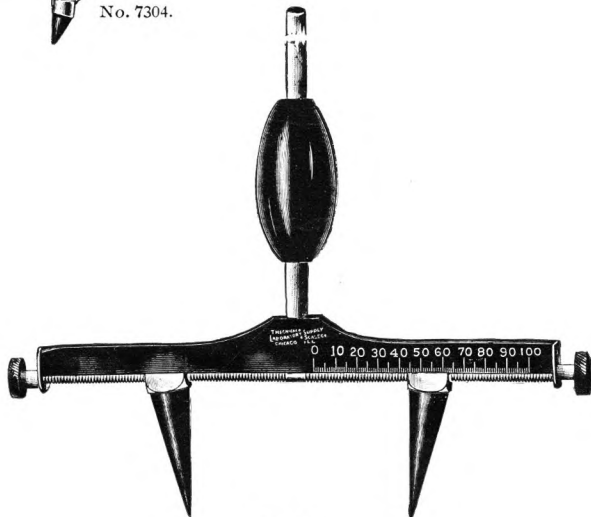

No. 7306.



No. 7308.

- 7300. Aesthesiometer (Titchener's), compass form plain (Sanford Exp. Psy. 364—Scripture, New Psy. 371).....net, \$2.00
- 7302. Aesthesiometer, compass form with graduated arc (Titchener Exp. Psy. 187—Scripture, New Psy. 371).....net, 3.00
- 7304. Aesthesiometer, caliper form with vernier (Scripture, New Psy. 371).....net, 3.00
- 7306. Aesthesiometer, (Jastrow's) improved form..... " 8.50
- 7308. Algometer (McDonald's) for indicating pressure up to 4 kilos, with vernier reading to 10 grams (Scripture New Psy. 303—Sanford Exp. Psy. 365).....net, 8.00
- 7310. Algometer, same as above, 8 kilos..... " 12.00
- 7312. " (Cattell) for indicating pressure up to 15 kilos in 1 kilo divisions.....net, 11.00
- 7314. Temperature Cylinder, for determining temperature sensations (Titchener Exp. Psy. 54—Sanford Exp. Psy. 7).....net, 1.00



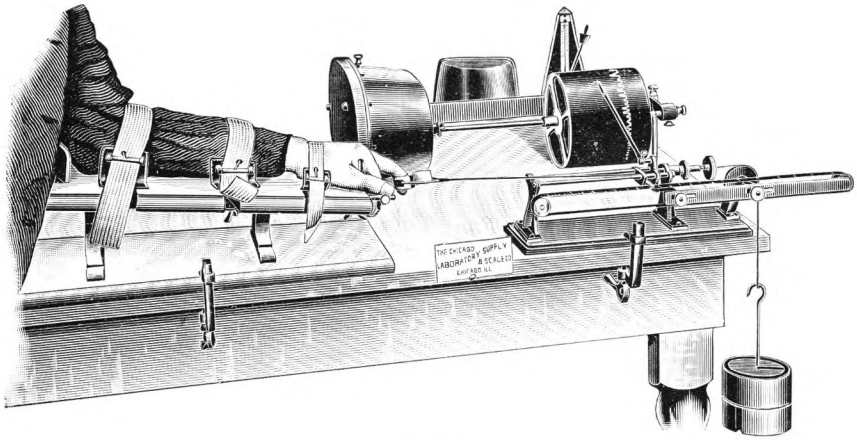

No. 7322.



No. 7316.

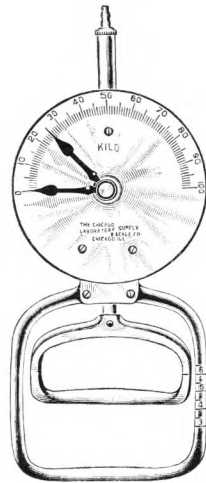

No. 7318.

- 7316. **Dynamometer, circular form**.....net, \$7.50
- 7310.     “     **and Dynamograph (Smedley’s), adjustable grip**  
           (Child Study report No. 2, Chicago Board of Education,  
           page 21).....net, 15.50
- 7320. **Dynamometer and Dynamograph, for fingers (Scripture, New**  
       **Psy. 124) improved form**.....net, 10.00
- 7322. **Ergograph, Mosso’s modified by Lombard, complete with arm**  
       **support and weights.** . . . . .net, 40.00
- 7324. **Suggestion Blocks, set of 16 (Scripture, New Psy. 273)** . . . . . “ 5.00
- 7326. **Touch Weights for minimal pressure (Sanford Exp. Psy. 365)** “ 5.00
- 7328. **Metronome with adjustable bell attachment**..... “ 4.50
- 7330. **Multiple Key (Scripture, New Psy. 139)**..... “ 17.50
- 7332. **Touch Key (Scripture, New Psy. 135)**..... “ 5.50
- 7334. **Noiseless Key.. (Scripture’s)** . . . . . “ 6.00

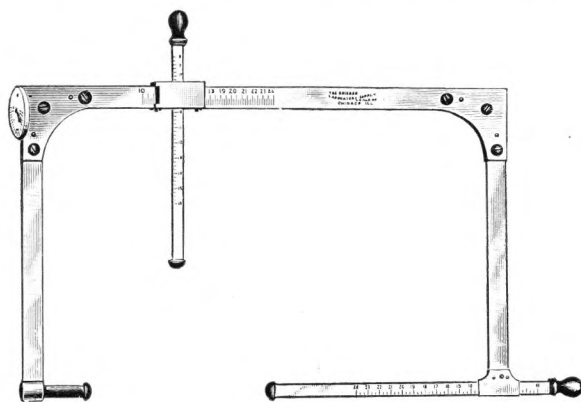

No. 7338.

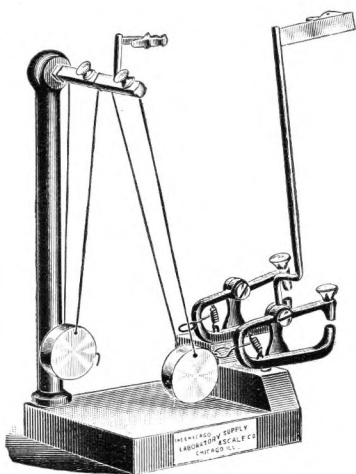

No. 7342.

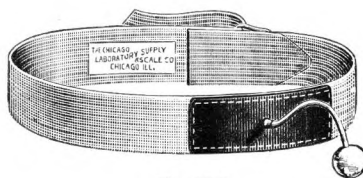

No. 7352.

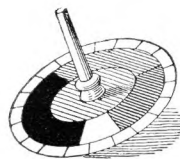

No. 7354.

7336.	Multiple Image Apparatus (Jastrow).....net,	\$2.00
7338.	Cephalometer (Smedley's) for cranial measurements..... "	20.00
7340.	Olfactometer, double, improved form (Sanford, Exp. Psy. 371— Scripture, New Psy. 372—Titchener, Exp. Psy. 80)....net,	5.00
7342.	Vernier Chronoscope, (Sanford's) .....	5.00
7344.	Telegraph Snapper (Sanford, Exp. Psy. 385)..... "	.25
7346.	Counter, Electric, registers to 9,999. Can be set to zero from any point .....	10.00
7348.	Counter, Hand, registers 999. Can be set to zero from any point.....net,	3.00
7350.	Stop Watch, one-fifth second..... "	7.50
7352.	Hypnotism Apparatus. (Scripture's)..... "	5.00
7354.	Pupils Color Top.....per doz., "	.60

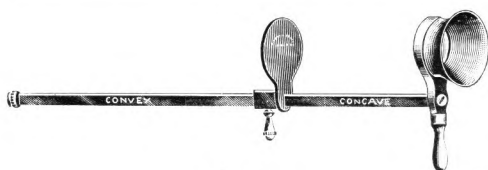

No. 7366.

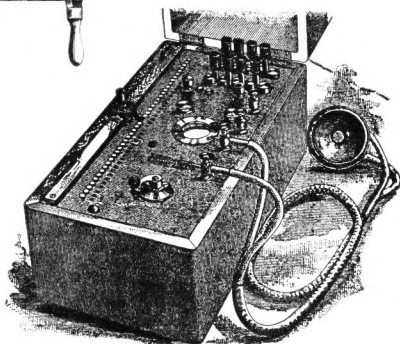

No. 7376.

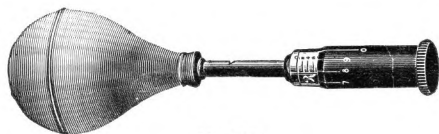

No. 7378.

- |       |   |         |
|-------|---|---------|
| 7356. | <b>Color Sense Tester</b> (Scripture, New Psy. 485).....net,  | \$10.00 |
| 7358. | <b>Semaphore Lantern</b> , arranged for above, fitted for oil or electric light.....net,  | 10.00   |
| 7360. | <b>Holmgren's Wool Skeins</b> for testing color sense (Sanford, Exp. Psy. 398).....net,   | 2.50    |
| 7362. | <b>Sight Test Cards</b> .....each, "  | .15     |
| 7364. | <b>Ophthalmoscope</b> , Loring's 7 lense, with tilting mirror, in morocco case.....net,   | 3.50    |
| 7366. | <b>Optometer</b> ....."   | .75     |
| 7368. | <b>Perimeter</b> ....."   | 9.00    |
| 7370. | <b>Stereoscope</b> ....."   | 1.50    |
| 7372. | <b>Book Stereoscope</b> ....."  | 1.50    |
| 7374. | <b>Pseudoscope</b> (Sanford, Exp. Psy. 280—Titchener, Exp. Psy. 146, (Jastrow's), either form.....net,  | 12.00   |
| 7376. | <b>Audiometer</b> ( Seashore's)for testing very accurately the hearing ability by determining the threshold of intensity for hearing (Seashore Univ. of Iowa, Stud. Psy. 1899 II 158) .net, | 50.00   |
| 7378. | <b>Galton Whistle</b> for highest audible tone (Koenig's), graduated.....net,   | 8.00    |
| 7380. | <b>Galton Whistle</b> , same as above, not graduated....."  | 5.00    |
| 7382. | " " by Prof. Th. Edelmann, a new improved form very much superior to the other styles (D. F.)..... net  | 15.00   |
| 7384. | <b>Automatograph</b> (Jastrow's) (Am. Jour. of Psy., vol. III, 398), with screen and writing frame, complete.....net,   | 12.00   |
| 7386. | <b>Automatograph Supports</b> (3) for raising same from table to standing height.....net,   | 2.25    |
| 7388. | <b>Automatograph Stylographic Pen</b> (to use in place of pencil), "  | 2.00    |
| 7390. | <b>Memory Apparatus</b> (Jastrow's) (Titchener, Exp. Psy. 202), "   | 12.00   |

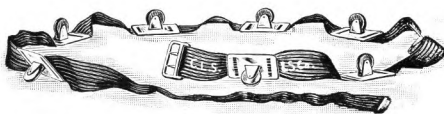

No. 7110.

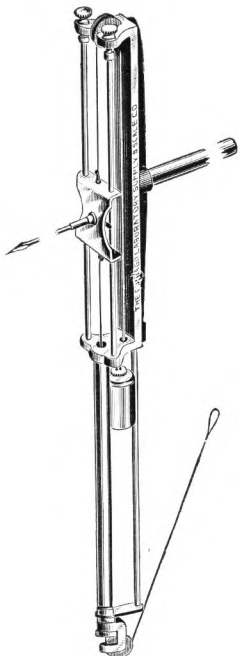

No. 7108.

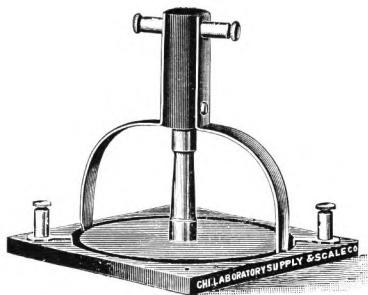

No. 7112.

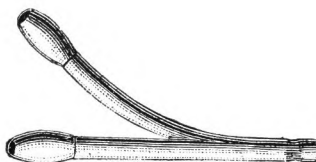

No. 7114.

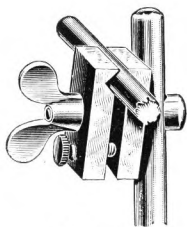

No. 7118.



No. 7116.

7108.	<b>Vertical Writing Lever</b> .....	net, \$10.00
7110.	<b>Belt Spiograph</b> (Hall Text Book Physiology, 202).....	“ 6.50
7112.	<b>Rheonome</b> (Fleischels, modified by Ludwig).....	“ 5.00
7114.	<b>Cannula, perfusion</b> , after Kronecker.....	“ 2.50
7116.	“ set of six, after Hall.....	“ 4.50
7118.	<b>Clamp, universal</b> , for holding time markers, etc.; very desirable .....	net, 1.50