

APPARATUS, TESTS  
*and*  
SUPPLIES

*for*

PSYCHOLOGY, PSYCHOMETRY, PSYCHOTECHNOLOGY,  
PSYCHIATRY, NEUROLOGY, ANTHROPOLOGY,  
PHONETICS, PHYSIOLOGY,  
*and*  
PHARMACOLOGY.

SUPPLEMENT

C. H. STOELTING CO.

MANUFACTURERS—PUBLISHERS—IMPORTERS—EXPORTERS

424 N. Homan Ave. Chicago, Ill., U. S. A.

## ORDERS

Specify catalog number and write out the name of the article—it saves time and annoyance for you and insures accuracy and promptness on our part.

Instruct us how you want us to ship—air mail, first-class mail, registered mail, parcel post, regular or special delivery, express, or freight. Parcel post and foreign shipments are always insured and the cost of the insurance charged to the consignee. If shipping instructions do not accompany order, we use our own judgment and ship the cheapest way consistent with speed and safety.

Be sure to write plainly your name, position, street and number or name of institution, state or province, and country. Attention to these details saves time and eliminates annoyance for both of us.

Orders are accepted subject to any price changes that may have become necessary after the catalog leaves the press.

Parties unknown to us will save time by submitting references at time of placing order.

Apparatus shipped for repairs should be carefully labeled or tagged with shipper's name and address, and accompanied by detailed instructions.

## CONSTRUCTION

It is impossible to guarantee that apparatus will always conform to catalog illustrations and descriptions. We must reserve the right to make any changes that improved manufacturing practice or fluctuating professional requirements make desirable. The greatest care is exercised in the prevention of deviations from the accepted standard in the production of psychometric tests.

## TERMS

Unless otherwise agreed upon, your remittance is promptly expected on the 15th of the month following the date of purchase. No cash discount is allowed.

Owing to the banking regulations of Chicago, collection charges are made on all checks drawn on banks outside of Chicago and New York. If it is not convenient to remit in Chicago or New York exchange, be sure to add the collection charge to your local check on the following basis: \$0.10 for amounts of \$1.00 to \$50.00; \$0.15 for \$50.00 to \$100.00, and  $\frac{1}{4}$  of 1% for amounts of \$100.00 and over.

Our foreign customers are expected to remit on the basis of United States currency. Unless otherwise agreed upon, our policy is to ship against documents.

## SHIPMENTS

We employ only experienced people in our shipping department and under the circumstances assume no responsibility after shipments leave our possession. The receipt which we receive from the carrier is virtually an acknowledgment that the shipment left our establishment in good order.

When shipments are delayed in transit, we will, upon request of the consignee, have a tracer started in order to expedite delivery.

Never give the carrier a clear or unconditional receipt, unless you are positively certain that the shipment is in good condition. Any damage should be noted on the carrier's receipt and the carrier's representative must be notified and given an opportunity to make an inspection. If there are no external indications of damage, but if later on after the shipment has been opened, breakage or any other damage is discovered, make an immediate claim for "concealed" damage.

All claims for damages must be made immediately by the consignee in writing, direct on the carrier. Any information required for the prosecution of claims will be cheerfully supplied.

Claims for shortage or mistakes will not be entertained unless we are notified within 48 hours after the shipment comes to hand.

## CREDITS

Under no circumstances should anything be returned for credit without notifying us and awaiting instructions. Our receiving clerk has strict instructions to refuse anything he is not authorized to receive.

Where a mistake has been made in ordering, the consignee has the privilege of returning the goods, but with the express understanding that the transportation charges must be prepaid, and that a charge of not less than 10% of the cost of the goods will be made to reimburse us for the expense incurred in filling the order. The exact charge will depend upon the character of the goods. Goods returned on this basis must be in a salable condition. Printed matter, if opened, is never accepted for credit.

## COPYRIGHT NOTICE

This catalog is copyrighted, and unauthorized reproductions of illustrations and descriptions will be prosecuted. Authors of books or articles for professional journals will, upon request, be given permission to use illustrations and descriptions, and in fact will be provided gratis with cuts, but under no circumstances do we permit the reproduction, for any purpose, of protected psychometric tests of any type.

## FOREWORD

After careful consideration, we have reached the conclusion that this is not the time for issuing a revised edition of our catalog. In fact, the present condition of business, the financial status of many of the educational institutions and clinics, and the state of flux in which the science of psychology finds itself, point to an extension rather than a revision. Under the circumstances, this supplementary catalog is issued with the hope that a normal demand for apparatus and tests will soon make itself felt, and thus provide us with a better basis for revising the next edition of our catalog.

In spite of the adverse conditions prevailing during the last five or six years, we have made material additions to our line. With customary caution, we have included only those items for which we have good reasons to expect a worthwhile demand. Among other things, this supplementary catalog includes a number of new pieces of apparatus, lantern slides and motion picture films especially devised for recent manuals. Motion picture films effectively supplement the work of lecture room and laboratory, and, in many instances, permit the students to observe and study experiments too lengthy and expensive for the smaller institutions to undertake.

Acting on the suggestions of a number of our friends, we have added an index of authors and designers. This index precedes the item index, and we hope will provide additional assistance in locating apparatus, tests, questionnaires, record blanks, charts, lantern slides, and motion picture films, in both the main catalog and this supplement. The page numbers preceded by the letter "S" refer to the pages of this catalog, while the other numbers refer to the pages of the original 1930 catalog and the two subsequent reprints. We have continued the innovation of giving references, and would suggest that you consult pages 201-207 of any of the three editions of the 1930 catalog in the event that you fail to find the publication on pages 55-57 of this catalog.

The last decade or more has been a period marked by unusual activity in the erection of buildings for educational purposes, but unfortunately, in many cases, equipment for the scientific departments has been drastically curtailed. The result of this condition is that many of our institutions are badly in need of essential equipment. While buildings are a necessity for the housing of faculty, students and equipment, and by their beauty or stateliness contribute to aesthetic enjoyment and pride, they are, nevertheless, not as essential as men and equipment. Men and equipment remain the foundation of prestige and effectiveness. The poorly-equipped lecture room, laboratory and clinic, is still something looked upon askance by scholars and invariably fails to inspire confidence. With the inevitable improvement in business and the accompanying improvement in the finances of the educational institutions and clinics, we feel sure that we are going to witness a marked renaissance of lecture rooms, laboratories and clinics.

In the future as in the past, we shall try to keep pace with the progress of the sciences in which we are interested, and, in fact, shall try to anticipate the demands likely to arise for new apparatus and tests. This effort to be of service has been rewarded in a very acceptable manner, and for this we extend our sincere thanks to our many friends in the United States, and also to our friends in foreign countries whose increasing demands materially aided in keeping us reasonably busy during the depression. Our thanks are also extended to those, who in person or by letter suggested improvements in existing apparatus or suggested the additions of desirable new apparatus and tests. A few words of appreciation must also be added for those who have inspired the development of new mechanical aids by the submission of experimental models which it has been our pleasure and privilege to perfect and make available.

The past year marked the fiftieth anniversary of our entry into the scientific apparatus business, and we look forward with pleasurable anticipation to being of service to you for many years to come.

C. H. Stoelting, Pres.  
E. E. Searles, Treas.  
W. C. Wideman, Secy.

C. H. STOELTING COMPANY

**MENSURATION**

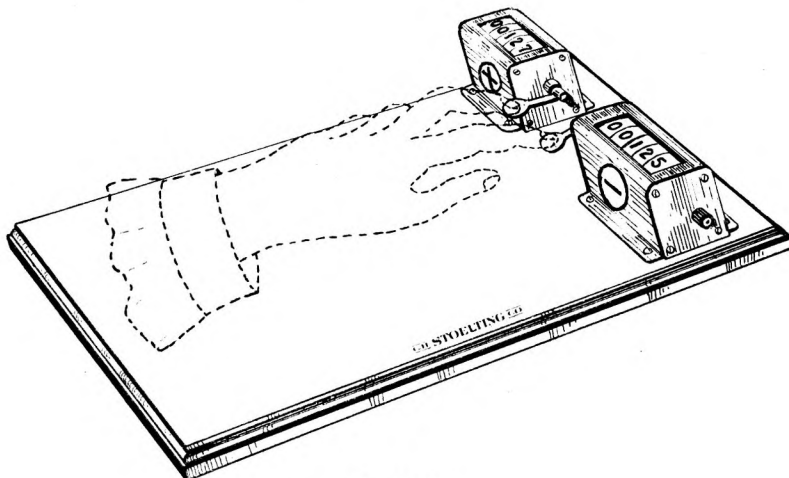

No. 10170.

Number		Price
10157.	<b>Correlation Chart, Boynton's.</b> This chart is built upon one statement of the product-moment method of measuring relationships. The operation is quite rapid, due to the fact that only three standard deviations are computed and these are worked out with certain constant aids. The chart is developed through a series of logical steps which materially reduce the possibility of errors. (12:293-333.) Per 25.....	\$ 2.00
	Per 100 .....	6.00
10170.	<b>Tabulator, Plus and Minus, Strong and Bernreuter.</b> A right- and a left-hand counter mounted on a base so that they can be operated by the first and second fingers for the recording of plus and minus scores. The tabulator is referred to in Strong's Manual for the Vocational Interest Blank and in Bernreuter's Manual for the Personality Inventory.....	15.85

**ANTHROPOLOGY**



No. 11216.



No. 12022.

11216.	<b>Pelvimeter.</b> Designed for use as a pelvimeter, but may be used for chest measurements.....	7.00
11219A.	<b>Caliper, Bertillon.</b> This is the No. 11219 caliper—listed on page 6 of the first, second, and third editions of the 1930 catalog—with the addition of a vernier permitting readings to .1 mm.	39.00

VISION

Number  
12022.

**Visual Acuity Test, Baker's.** Devised by Dr. Baker and his associates in the Psychological Clinic of the Board of Education, Detroit, Mich. The chart is somewhat on the order of the Reber chart and is composed of solid objects familiar to children and illiterates.....

Price

\$ 1.50

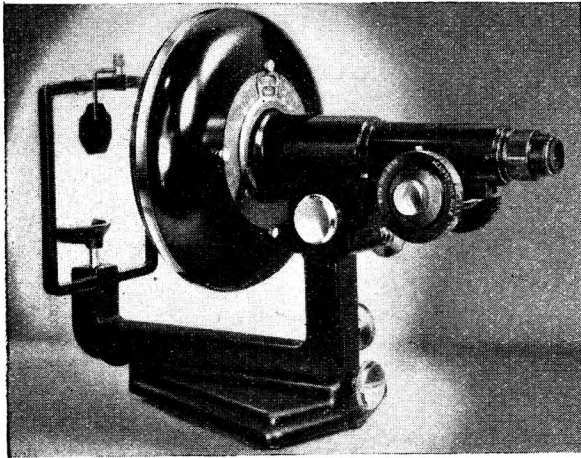

No. 12140.

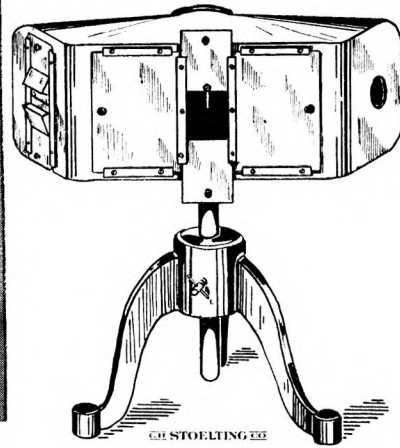

CH. STOELTING CO.  
No. 12156.

**12140. Ophthalmometer, C.-I.** The well-known "one-position" instrument with two pairs of mires—a separate pair for each principal meridian—each pair being peculiarly adapted to this purpose. The mires used in the primary cannot be used in the secondary position. Once the primary position is located, no further change in position of the mires or the telescope is required. The tendency on the part of the subject to move his eyes when the instrument is turned to the secondary position is entirely eliminated. This instrument has many advantages not possessed by the old style "two-position" instrument. For instance, the principal meridian of an eye possessing corneal astigmatism may be located by rotating the mires through an arc of only 90°. By limiting the rotation to this extent the operator is compelled to locate the principal meridian lying in the horizontal section of the eye first; in other words, the primary position will necessarily have to be correct. Can be supplied with illumination for either 110 or 220 volt current. Specify which is wanted. (S.P.: 1062-1064).....

235.00

**12156. Phakoscope, Helmholtz's.** Designed to demonstrate the change in curvature of the crystalline lens of the eye, more especially of the anterior surface during accommodation. The observer sees two small, bright, upright images of light when the observed eye looks straight ahead at a distant object. These are the corneal images. The observer will also see two larger distinct images from the anterior surface of the crystalline lens and two much smaller and dimmer images from the posterior surface of the lens. The last two are seen with more or less difficulty. When the subject accommodates, the middle images become smaller and approach the corneal image while the others undergo no perceptible change. At the same time, the iris is noticed to contract. (K.H.P.: 744-747; L.S.: 928, 929; S.P.: 980-982, 1059, 1060; S.P.P.: 333, 334; S-S.E.P.: 151).....

90.00

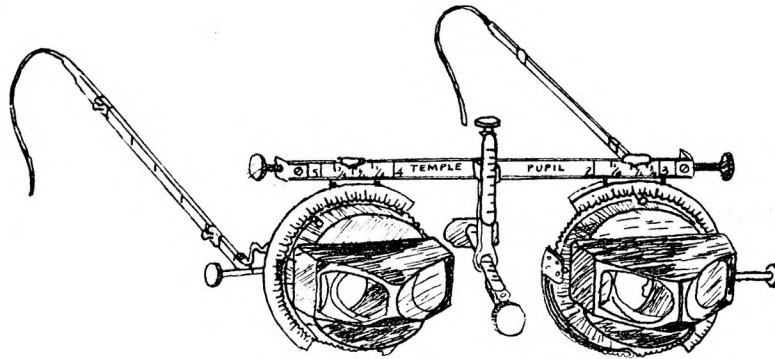

No. 12193.

**12193. Combined Metascopes and Diploscope, Boder's.** This apparatus consists of a trial frame such as used in ophthalmological work, and a pair of circular prism carriers, each carrying two Porro prisms, attached base to base but separated by a thin piece of opaque white

Number		Price
	paper. The trial frame is provided with adjustable temples, means for varying the pupillary distance and position of the bridge, graduated arcs for the lens cells, and thumbscrews for exact alignment of the prisms. (A. J. o. P. Oct. 1935: 688-690).....	<b>\$33.35</b>
<b>12224.</b>	<b>A-B-C Vision Test, Miles'.</b> A modification of the Parson's manoptoscope for the study of ocular dominance. This test includes 3 cardboard V-scopes, 10 two-spot cards and 10 picture cards. It is an inexpensive test for studying the twin phenomena of eyedness and handedness. (J.o.Ex.P. 1929, 12:113-126; J.o.G.P. July 1930: 412-430; 72:261-266; 128A:61, 62; 136F:166-167)....	<b>2.25</b>

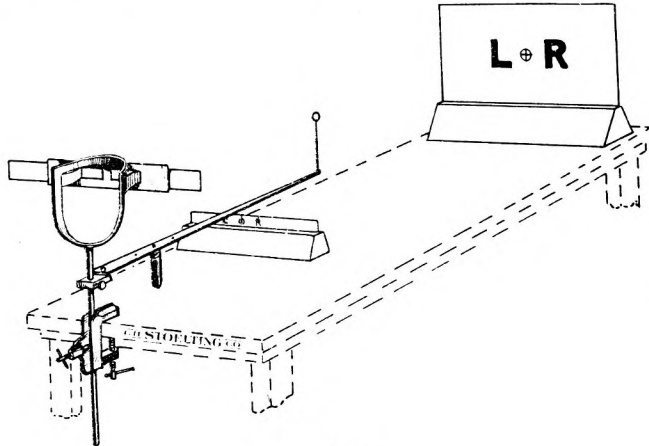

No. 12225.

<b>12225.</b>	<b>Manoptometer, Lund's.</b> Devised for the quantitative measurement of eye dominance. The apparatus is designed for use on a laboratory table. It consists of a head-rest attached to which is an extension bar carrying a mounted circle, a table clamp and a screen with objects and letters for fixation. (A.J.o.P. Jan. 1932: 181-183; A.J.o.P. Oct. 1932: 756-762).....	<b>22.00</b>
---------------	--------------------------------------------------------------------------------------------------------------------------------------------------------------------------------------------------------------------------------------------------------------------------------------------------------------------------------------------------------------------------------	--------------

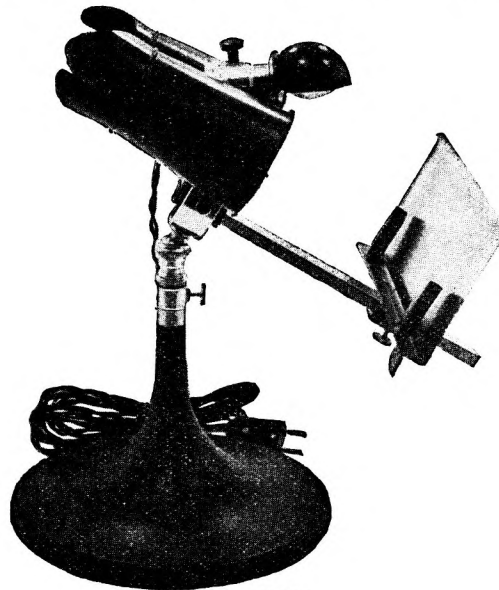

No. 12226A.

<b>12226A.</b>	<b>Telebinocular.</b> This is a new type of stereoscope, capable of being used in a number of different ways for the study of monocular and binocular vision, and hand and eye co-ordination. The oculist and optometrist use it for treatment of all such conditions as amblyopia, heterophoria, and heterotropia, where the two eyes do not share equally in the task of normal stereoscopic vision. It has been found very effective for stimulating fusion, demonstrating stereopsis, in post-operative fusion training, insufficient duction, monocular suppression, anisometropia, quantitative measurement of heterophoria, heterotropia, etc. The instrument consists essentially of three parts: the telebinocular proper with adjustable stereogram-holder or stage and removable septum, a support with circular base, and an attachable incandescent lamp for the 110-volt lighting circuit, which may be used for individual or simultaneous illumination of the right and left halves of the telebinocular head. The versatility of the Telebinocular makes it a highly desirable Brewster Stereoscope for your laboratory equipment. It provides its own illumination, and where desirable for drawing purposes, the Telebinocular	
----------------	---------------------------------------------------------------------------------------------------------------------------------------------------------------------------------------------------------------------------------------------------------------------------------------------------------------------------------------------------------------------------------------------------------------------------------------------------------------------------------------------------------------------------------------------------------------------------------------------------------------------------------------------------------------------------------------------------------------------------------------------------------------------------------------------------------------------------------------------------------------------------------------------------------------------------------------------------------------------------------------------------------------------------------------------------------------------------------------------------------------------------------------------------------------------------------------------------------------------------------------------------	--

Number		Price
	proper or head may be readily removed from the support and placed in an upright position for experiments in hand and eye co-ordination, such as requiring the subject to make drawings, tracings, etc. It may also be used in this way as a book stereoscope. Below will be found listed the different types of accessories, such as comparative stereograms, regular stereograms, adjustable stereograms, and drawing cards used by the oculists and optometrists.....	\$ 15.70
12226B.	<b>Stereograms.</b> Set of 100, which includes fifteen pairs of adjustable and eight pairs of contrast stereograms .....	36.00
12226C.	<b>Stereograms</b> for color fusion. Set of 12 plates.....	3.90
12226D.	<b>Drawing Cards</b> for hand and eye co-ordination. Set of 30 pads for right and left eye—600 cards providing for 1200 graphs.....	6.70
12226E.	<b>Case</b> for holding all of above equipment.....	3.80
12226F.	<b>Telebinocular.</b> No. 12226A, complete with accessories Nos. 12226B-C-D-E listed above. A manual accompanies this complete set of equipment.....	66.10
	<b>N.B.</b> We supply at pro rata figures one-half and one-quarter sets of No. 12226B and No. 12226D. Replacement: single stereograms, No. 12226B, \$.50; single pads of drawing charts, each pad with 40 duplicate graphs, No. 12226D, \$.35.	
12226G.	<b>Telebinocular.</b> This is the No. 12226A Telebinocular without support, illuminant and septum...	4.40
12226H.	<b>Support</b> for No. 12226A Telebinocular.....	5.00
12226I.	<b>Illuminant</b> for No. 12226A Telebinocular.....	3.35
12226J.	<b>"Stereoscopic Technic."</b> A manual covering the No. 12226F Telebinocular, in paper binder...	2.80
12238.	<b>Book Stereoscope, Scripture's.</b> Convertible—may be used with a book or in the regular way, with stereograms. (195:201-213).....	12.50
12241A.	<b>Stereoscope and Telestereoscope.</b> This model is substantially constructed of wood. The adjustable panels rotate and are supplied on one side with diagram holders, and the other side carries a large mirror, so as to be able to convert the stereoscope into a telestereoscope. (187:406-411) .....	35.00
	<b>Stereograms, Anatomical, Edinburgh University.</b> Prepared under the direction of the Department of Anatomy. These stereograms are prepared with the greatest of care from actual dissections, they are far superior for individual study to charts, and give far more reliable information to the student than the average model. The photographs are mounted at the bottom of a large chart. The upper part of the chart contains a detailed description of the different parts indicated on the stereogram by a method of flag labels by which any structure can be identified with the greatest ease.	
12248A.	<b>Section I.</b> Contains 10 stereograms covering cranio-cerebral topography and 21 stereograms covering the central nervous system. Stereograms 1-8 inclusive, covering cranio-cerebral topography, are from the head of a child; 9 and 10 from an adult male; stereograms 11-31 inclusive cover different sections and aspects of the brain. (De luxe container included).....	9.25
12248B.	<b>Section II.</b> Contains 4 stereograms covering the central nervous system (completing a set of 25 stereograms, 21 of which are included in Section I) and 27 stereograms of the head and neck which include surface anatomy, back of neck, posterior triangle, side of neck, spinal canal, front of neck, parotid region, submaxillary region, pterygmaxillary region, sagittal section of the head, nose, and pharynx and larynx and larynx. (De luxe container included) .....	9.25
12248J.	<b>Section X.</b> Contains 36 stereograms covering normal anatomy of temporal bone and internal ear together with several illustrations of surgical operations. (De luxe container included)...	10.50
	<b>N.B.</b> There are also available sections on Thorax, Heart, Pericardium; Mediastinal-Septum. Lungs, Superior Extremity; Abdomen. Inguinal Region, Lumbar Region; Abdominal Viscera, Perineum; Pelvis and Inferior Extremity; Internal Anatomy of the Face, Kinesiology, Physical Education; Pathological Anatomy of the Eye. Details on application.	
12250A.	<b>Stereograms, Convertible, Moore's.</b> A set of 6 backgrounds—yellow, green, red, blue, black, and white with 6 figures of each color of the backgrounds. The backgrounds have 2 square apertures with pockets at the rear for holding the figures. This set of convertible stereograms was devised for studying the contrast of figure and ground. (A.J.o.P. 38, 1927; 194-226).....	9.45
12257B.	<b>Stereograms, Size-Constancy, Weber's.</b> Set of 16. Since the amount of the constancy-correction does not vary greatly with the absolute size of the disk, a white disk 30 cm. in diameter was selected for this new series. This cardboard disk was mounted on a wooden disk of the same area and the whole secured to an oak upright. When in position for photographing, the center of the disk was 80 cm. from the ground; the same height as the lens of the camera. The disk was photographed at four distances of 3, 6, 9 and 12 meters from the camera objective. The camera stood on a firm table with the various positions of the camera carefully marked on the table-top. For each one of the four distances 4 pairs of photographs were secured. (1) in which the camera is not moved (i.e., in which the paired photographs on a stereogram are duplicates), (2) in which the camera is moved 3.5 cm. to the right and then 3.5 cm. to the left of the central position. This lateral separation of 7 cm. gives two photographs representing normal or nearly normal disparition. (3) A lateral separation of 14 cm. giving exaggerated disparition. (4) A lateral separation of 21 cm. giving exaggerated disparition. The paired photographs, even for the extreme separation of 21 cm. fuse well in the stereoscope. With few exceptions, students can make an adjustment of the stereoscope for one stereogram of the entire set, and then use this adjustment for all sixteen. Magnification is changed relatively little by changing the distance between the eye and the lenses of the Brewster Stereoscope, or the distance between the lenses and the stereogram in the carrier. The Brewster type of Stereoscope magnified its object 2.035 times. This constancy of magnification suffers appreciably for observers showing certain abnormalities of vision. Various experimental procedures suggest themselves, but a convenient and effective method is to prepare a chart with some 30 or 40 "comparison circles" drawn on it, varying from one so small that no student would select it as equal to even the smallest disk on a photograph, to a disk so large that no student would select it as equal to even the largest of the photographed disks. The student examines the disk on the stereogram and then turns to the chart of comparison circles and selects one of equivalent area. Such comparison charts are easy to prepare in any laboratory. (A.J.o.P. July 1935:436 448; 16:213, 214, 215, 267).....	9.75

Number		Price
12257C.	<b>Stereograms, Form-Constancy, Weber's.</b> Set of 15. To study the tendency of the observer to see an object in its "true" form, despite contradictory impressions in immediate perception, there was used the instance of the inclined circle, which appears elliptical. Previous studies show that the tendency to see the inclined disk as more circular than it really is (according to the laws of perspective) is more marked if the object judged is a "real" object, like the top of a table, the end of a tunnel, etc. The form constancy stereograms consist of paired photographs of a table of the "tilt-top" variety. The diameter of the table top was 48 cm. It was photographed at a constant distance of 7 ft. Pairs of photographs were made with the table-top tilted at angles of 20, 30, 40, 50 and 60 degrees to the horizontal plane. For each angle, three pairs of photographs were taken: (1) no binocularity, (2) total lateral separation of 5 cm. between the two positions of the camera, (3) a total lateral separation of 10 cm. between the two positions of the camera. These three positions give a variation from 0 disparition to slightly more than normal disparition. Because the total disparition of the object from the camera was smaller than in the size-constancy series No. 12257B, it was necessary to select less extreme degrees of disparition in this series. As in the size-constancy series, a simple procedure is to have the observer estimate the degree of circularity of a photograph disk (table-top) and select, from a chart of comparison ellipses and circles one of equivalent form. It is customary to express the degree of ellipticity of a disk in terms of the ratio of the long to the short axis (long axis or horizontal axis divided by the short or vertical axis). This "index" for a circle would be 1.....	\$ 9.00
12259A.	<b>Pyramid, Truncated with square base (50:X33)</b> .....	.75

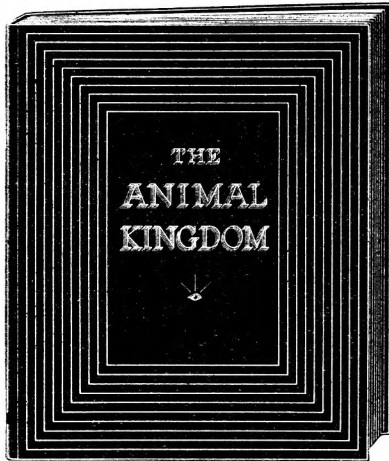

No. 12260A.

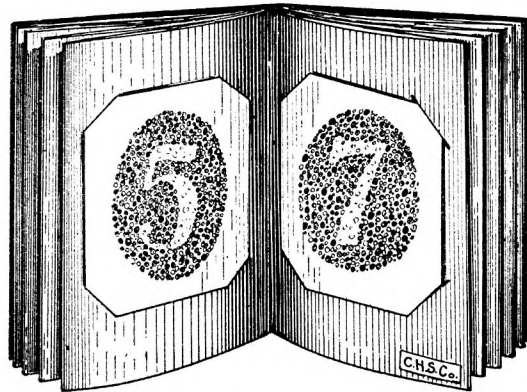

No. 12326A & B.

12260A.	<b>Plastographs, Neumann's.</b> "The Animal Kingdom," an attractively bound book approximately 8½x11 in. containing thirty-one 6¼x6½ in. views of habitat groups of African, Asiatic, and North American animals, taken among the exhibits at the Field Museum of Natural History in Chicago. The pictures are carefully printed in red and green-blue and each book is accompanied by two pairs of red-blue spectacles (ortho-scopes). The pictures have all the appearance of being actually in three dimensions, or relief—that is, with the various objects in their relative vertical planes just as the observer would see them in nature .....	2.25
12297A.	<b>Screen, One-Way.</b> This is a sectional screen mounted in a wood frame 3 ft. x 3 ft. 3½ in., which can be built up to meet requirements. It is made of a fine mesh screen painted white on one side so that the observer can not be seen by the observed. It is very effective for the study of children and animals. In the study of animals it is advisable to use the screen in connection with a blower, blowing from the animal, in order to eliminate the human odor. (68:30-36, 58-68; 136G:380).....	9.50
12299.	<b>Paste, Library,</b> 4½ oz. jar, with brush. (119:X12-44; 225:X38).....	.45
12314.	<b>Color Perception Test, Philip's.</b> This test enables one to gauge the speed and accuracy of the color perception of individuals. It assigns a rating, expressed as a percentile of the general population, to one's ability to perceive color as a mass pattern. The extent of one's color weakness is thereby detected. It has zero correlation with intelligence, mental and chronological age. The norms are the same for every age, from 10 years of age to university level. At each age level, however, there is a wide divergence in ability. The test material is contained in a pack of forty 2 5/16 x 3 7/8 in. cards, on each of which are printed 36 randomly distributed dots in 4 colors. The subject names the predominating color on each card. Three trials in all are given, with a definite time limit for each trial. The total time for giving and scoring the test does not exceed 15 minutes. This test has been standardized on over 500 subjects. Norms are presented, so that one may ascertain from the subject's score, just what percentile he is in. The reliability of the test is high, and the test is easy to administer and to score, even at the younger ages. The material, with directions, and 4 sample cards is neatly packed in a box which may be used for sorting. (A. J. o. P., Oct. 1937).....	7.50
44034.	<b>Scoring Sheets, Philip's,</b> for No. 12314. Per 25.....	.50
	Per 100 .....	1.50
12317.	<b>Color Perception Test, Nela.</b> Devised by Dr. Knight Dunlap, while at Johns Hopkins University. It consists of three sets of colored worsteds similar to those used in the Holmgren test	



Number		Price
	but attached in clusters of three to three black cloth backgrounds. The test comprises 165 skeins of colored worsteds.....	\$ 22.25
12326A.	<b>Color Perception Test, Ishihara's.</b> This edition, the 7th, is an extension of the original 16 color plates, and consists of 32 plates designed to cover, in the most thorough manner, every phase of color perception. There are tests for both the literate and the illiterate, and as the test plates are not permanently mounted, the order of presentation can be readily varied. Some years ago Dr. J. H. Clark of Johns Hopkins University published a report on color perception tests in the American Journal of Physiology, and in this article stated that test 9 of that edition, alone was a better test of color vision than all of the plates of the other two well-known pseudo-isochromatic tests together. Dr. P. v. Planta of the University Eye Clinic, Basel, declared in an article in Graefe's "Archives for Ophthalmology" that the findings of the Ishihara tests are final and that the accuracy of the findings could be duplicated or exceeded only by elaborate mechanical devices. The International Ophthalmological Conference held at Amsterdam in 1929, recommended the Ishihara tests as the best available. Since our introduction of these tests in the United States eleven years ago, thousands have been sold to the psychologists, ophthalmologists, optometrists and to the examining surgeons of the railways, marine service, Army, Navy and Air service. Detailed instructions accompany each test.....	9.00
12326B.	<b>Color Perception Test, Ishihara's.</b> An abridged form devised for use by the teacher, employer and those engaged in educational and vocational guidance, and in fact, anyone interested in detecting color blindness in individuals taking up studies or employment where color perception is a desideratum. This abridged edition contains but 11 plates—5 plates less than the 6th and preceding edition. In this abridged form there are no tests for illiterates. Detailed instructions are bound into each copy and, as the tests are permanently mounted, the order of presentation cannot be varied.....	4.50
12408.	<b>Peripheral Vision Cards, Metfessel's.</b> Set of 12 with 6 blanks, support, and key rings for suspension. (128:48; 128A).....	6.40
12422.	<b>Perimeter, Franz's.</b> An inexpensive perimeter made of cardboard. Designed for temporary individual use. (58A:CS-14).....	1.70

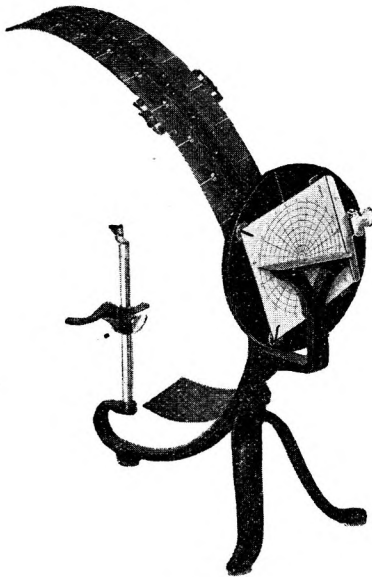

No. 12432.

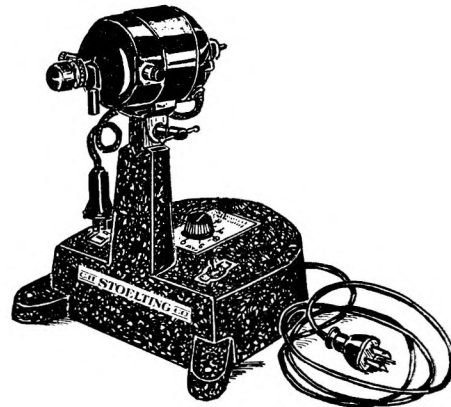

No. 12610.

12432.	<b>Perimeter, Manual Registering.</b> An excellent laboratory perimeter at a moderate price. Provided with a broad metal arc, revolving chart-holder, and the sight-hole through the center of rotation. The moving object-carrier is adapted for holding any of the five test-objects, 5 mm. in size, in red, green, blue, yellow, and white, or a sixth white button, 10 mm. in size. There is also supplied a steel handle for holding the test-objects, the same as practiced in the use of the hand perimeter. (32:112, 113; 78:528; 136F:144, 145; 659D:13-18).....	40.00
12432A.	<b>Perimeter, Manual Registering.</b> The No. 12432, provided with a special object carrier which contains all of the different sized apertures and colors of the McHardy perimeter.....	45.00
12432R.	<b>Perimeter Charts, Rights,</b> for No. 12432 and 12432A. Per pad of 100.....	2.00
12432L.	<b>Perimeter Charts, Lefts,</b> for No. 12432 and 12432A. Per pad of 100.....	2.00
12504.	<b>Color Projection Boxes, Ford's.</b> Two required. (50:X1). Per pair.....	18.00
12522.	<b>After-Image Apparatus, Positive, Metfessel's.</b> Consisting of an incandescent bulb mounted in a box with a sliding lid. The top of the lid is painted white in order to serve as a screen for the after-image. (128:47; 128A).....	4.80
12525.	<b>Fixation Cross, Metfessel's.</b> Black, for attaching to projection screen. (128:44; 128A).....	.60
12528.	<b>After-Image Chart, Tinker's.</b> Red-cross on gray cardboard. (51A:X1).....	1.00
12531.	<b>Disks, Brightness and Saturation, Warren and Carmichael.</b> Set of 2 disks: A and B. For use on the 12610 color mixer. (128:43; 128A).....	4.50

Number		Price
<b>12610.</b>	<b>Color Mixer, Electric.</b> A new model replacing the No. 12611, listed in the first, second and third editions of the 1930 catalog. This model, like the No. 12611, can be operated on the 110 volt, A.C. or D.C. The motor is mounted sufficiently high to permit the use of disks 18½ in. in diameter and may be swung through an arc of 90 degrees and clamped in any direction, at any angle between the horizontal and vertical positions. The color mixer is substantially constructed and weighs about 15 pounds, making it unusually stable. Inside the 8x8½ in. base, which is provided with rubber supports and 4 screw holes for permanent mounting on a table, is an adjustable circular rheostat of 250 ohms, with a carrying capacity of .775 amperes, devised to be used independently with other apparatus by plugging in on the socket used for the motor plug. A 10 ft. cable with non-breakable plug is permanently attached to the rear of the base. The rheostat provides continuous variation of resistance, and is provided with a circular scale divided into 10 equal parts. These graduations permit the making of approximate records of speed, although a universal motor of this type cannot be depended upon to furnish constant speeds. The armature shaft is supplied with a pulley and one of our No. 12618 color disk arbors which makes it possible to attach the thinnest paper disks without damaging them during the process of locking. The motor consumes from 60 to 90 watts and has an approximate range of speeds from 300 to 13,000 R.P.M., depending upon the load.....	\$ 35.00
<b>12610A.</b>	<b>Color Mixer, Electric.</b> Similar to No. 12610, but designed for the 200 volt A.C. or D.C.....	42.50
<b>12612.</b>	<b>Color Mixer, Electric.</b> Similar to the old No. 12611 but made for operation on the 220-volt A.C. or D.C.....	31.00
<b>12622A.</b>	<b>Rheostat</b> for use with the No. 12612 color mixer on the 220-volt A.C. or D.C.....	8.75

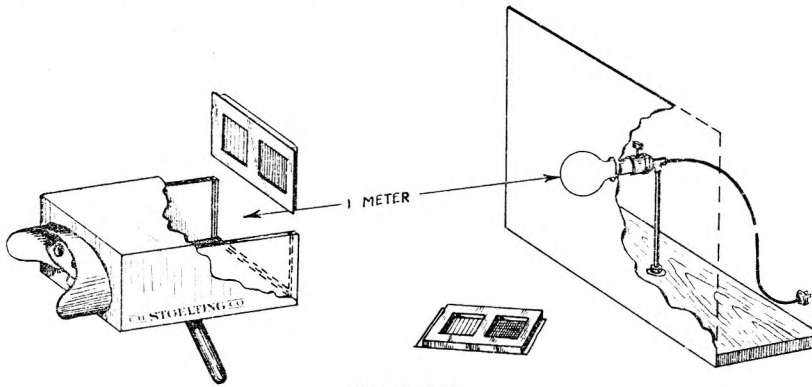

No. 12641.

<b>12641.</b>	<b>Color Mixer, Binocular, Hecht's.</b> Consisting of an observation box (10x15x30 cm.), with hood and four Wratten Filters—No. 29 red, No. 58 green, No. 16 yellow, No. 44A blue—and a support carrying a screen with a hole through which projects a 250- or 100-Watt concentrated filament lamp with connecting cord. For use on the 110-volt A.C. or D.C. (136:265; 136F:174)..	40.00
<b>12673-20.</b>	<b>Paper, Black Velvet,</b> 50x60 cm.....	1.00
<b>12692.</b>	<b>Paper, Hering's, Gray.</b> Book of 30 shades, 3¼x7½ in.....	2.00
<b>12692A.</b>	<b>Paper, Hering's, Gray.</b> 30 shades, 50x60 cm. Per sheet.....	.15
<b>12692B.</b>	<b>Paper, Hering's, Gray.</b> Set of 30 shades, 50x60 cm.....	6.00
<b>12693H.</b>	<b>Paper, Hering's, Gray.</b> 4 sets each of 2 medium shades of series No. 12692B.....	2.00

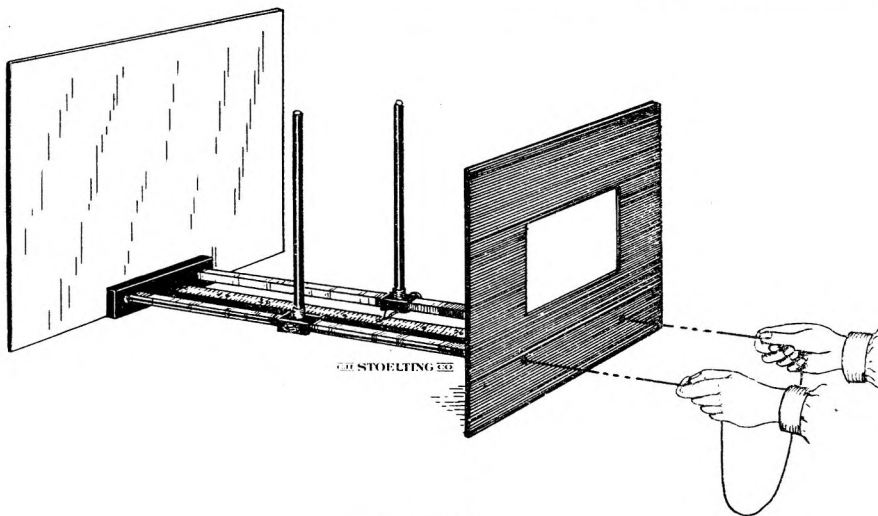

No. 12805.

Number		Price
12805.	<b>Depth Perception Apparatus</b> , Howard and Dohlman's. Designed for measuring depth discrimination. One of the tests used in aviation. It consists of a background screen and a diaphragm between which are mounted two adjustable upright rods, one of which may be moved back and forth by means of strings operated by the examinee. The examinee's problem is to lineup his rod with the examiner's setting of the other rod. (11A; 32D; 301; 240:X22; X24)	\$35.00
12864A.	<b>Photometer</b> , Weston Foot-Candle Meter. Operating equipment consists of an indicating instrument, a three-way toggle switch, and a Photronic photo-electric cell all mounted on a Bakelite panel. The instrument reads directly in foot-candles and has three ranges: 0-50, 0-250, and 0-500 foot-candles. It is completely self-contained and ready for instant use at all times. Does not require the use of batteries, voltage or lamps. It has an indefinite life with permanent calibration. Size: 7 in. long, 3½ in. high, 2¼ in. wide; weight, 1.8 pounds.....	50.00
12864B.	<b>Photometer</b> , "Sight Meter." This meter is not only scaled in foot-candles, but has literal indications of the minimum amount of light needed for certain seeing tasks. It provides a means for checking intensities of light so that intelligent control of natural and artificial lighting may, at all times, be exercised. It is very useful in checking intensity of light on visual acuity charts, room lighting, standardizing illumination in experiments where the intensity of light is a factor, and, taken as a whole, it is a very desirable and comparatively inexpensive piece of equipment for any psychological laboratory.....	27.75
12865.	<b>Photometrical Glasses</b> , Tscherning's. See detailed description in catalog of Tests for Color Perception, Visual and Auditory Acuity, pages 6 and 7.....	120.00

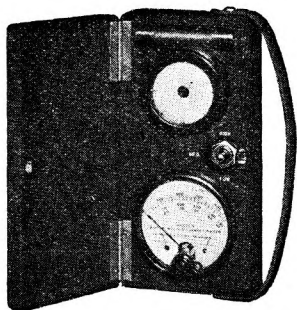

No. 12864A.

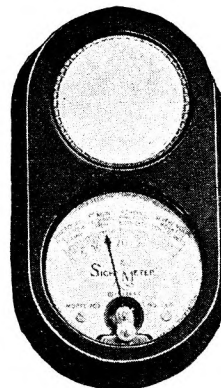

No. 12864B.

12874A.	<b>Tint Disk</b> , Metfessel's. A 12 in. metal disk with a white background on the same order as the No. 12874C Brightness Disk but supplied with incomplete concentric green circles instead of black. (128:42, 43; 128A:24, 25).....	5.50
12874B.	<b>Shade Disk</b> , Metfessel's. A 12 in. metal disk on which is painted five incomplete concentric black circles separated by a narrow white line. The breaks in the circles are filled in with green and begin with a section of 180 degrees in the marginal ring and decrease in the proper ratio toward the center, so that each ring or step will produce green in varying degrees of intensity. (128:42, 43; 128A:24).....	7.70
12874C.	<b>Brightness Disk</b> , Metfessel's. A 12 in. metal disk with a white background on which is painted five incomplete concentric black circles, separated enough to permit the background to show a narrow white line between them. The break in the circles are all on one-half of the disk and begin with one of 180 degrees in the marginal ring and decrease in the proper ratio toward the center, so that each succeeding ring or step will give one-half the brightness of the one preceding. (128:23, 24).....	5.00

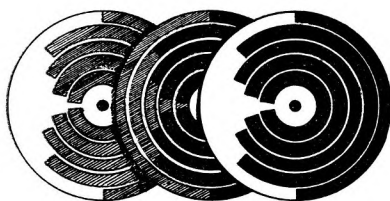

CH. STOELTING CO.  
Nos. 12874A-B-C.

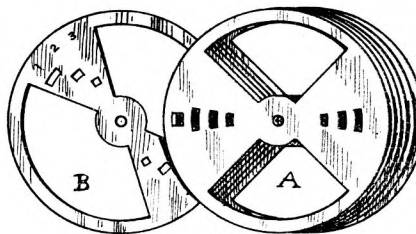

CH. STOELTING CO.  
No. 12877.

12877.	<b>Brightness Discrimination Device</b> , Metfessel's. This series of disks is designed to be used on a rotator with a parallel beam from a projection lantern. There are two types of disks. The "A" type disks are similar to the outside disk in all respects except the distance on the circumference of the small slits. The "B" type disk is aluminum inasmuch as it is used as the backing for the various "A" types. A numbered lantern slide accompanies each set of disks. (128:49, 50; 128A:30-31).....	12.00
12877A.	<b>Rocker</b> , Metfessel's. For No. 12610 and 12611 Color Mixers. (128:49, 50; 128A:32).....	1.50

**AUDITION**

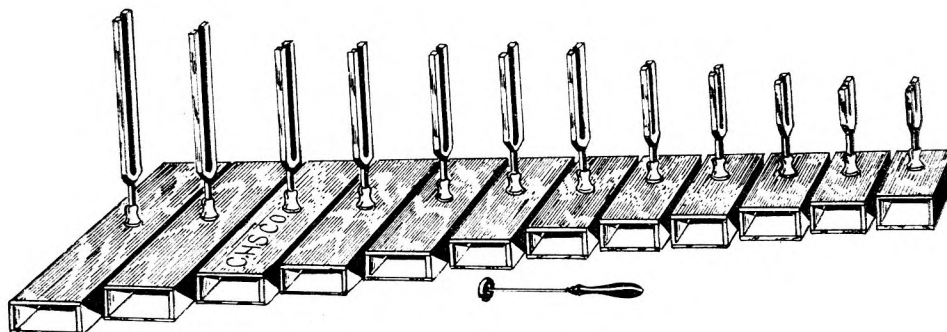

No. 14024.

Number	Price
<b>14024.</b> Tuning Forks. Mounted on synchronized resonance cases. Set of 12: 128, 256, 320, 384, 512, 640, 768, 896, 1024, 1152, 2048, and 4096 d.v., physical pitch, C <sub>2</sub> -C <sup>2</sup> . (241:X22).....	<b>\$125.75</b>



No. 14025.

**14025.** Tuning Forks. Made from an extremely light, elastic aluminum magnesium alloy stock of 13x31 mm. cross section, which will not rust or corrode. The prongs of these forks range in length from approximately 5 in. to 7 1/8 in. The tones are loud and of unusually long duration. Forks from this alloy are, in every way, superior to the best steel forks. The forks carried in stock are tuned to the physical pitch, but we can, on short notice, furnish forks tuned to the international pitch (A=435 d.v.) or the concert pitch (A=440 d.v.). In ordering please specify whether the physical, international or concert pitch is desired.

C 256 d.v.....	8.50
D 288 d.v.....	7.75
E 320 d.v.....	7.75
F 341.3 d.v.....	7.75
G 384 d.v.....	7.25
A 426.7 d.v.....	7.25
B 480 d.v.....	7.25
C 512 d.v.....	6.50

<b>14025A.</b> Tuning Forks. Complete set of 8 forks, No. 14025, C <sup>1</sup> (256 d.v.) to C <sup>2</sup> (512 d.v.), inclusive, tuned to physical pitch. (A=426.7 d.v.).....	<b>60.00</b>
<b>14025B.</b> Tuning Forks. Similar to 14025A but tuned to international pitch (A=435 d.v.).....	<b>60.00</b>
<b>14025C.</b> Tuning Forks. Similar to 14025A but tuned to concert pitch (A=440 d.v.).....	<b>60.00</b>
<b>14025D.</b> Tuning Forks. A set of No. 14025A, 14025B or 14025C, mounted on carefully synchronized resonance cases .....	<b>86.00</b>
<b>14026A.</b> Tuning Forks. A set of 10 forks—five sharps and five flats—for the octave C <sup>1</sup> -C <sup>2</sup> (256-512 d.v.)..	<b>220.00</b>
<b>14027.</b> Tuning Fork. C <sub>2</sub> (128 d.v.).....	<b>10.00</b>
<b>14027A.</b> Tuning Fork. No. 14027 mounted on resonance case.....	<b>15.00</b>
<b>14054.</b> Beeswax, Yellow. (110:X2-11; 225:X28). Per pound.....	<b>.90</b>
<b>14222.</b> Whistle, Song, Ludwig's. Nickel-plated with sliding piston.....	<b>1.66</b>

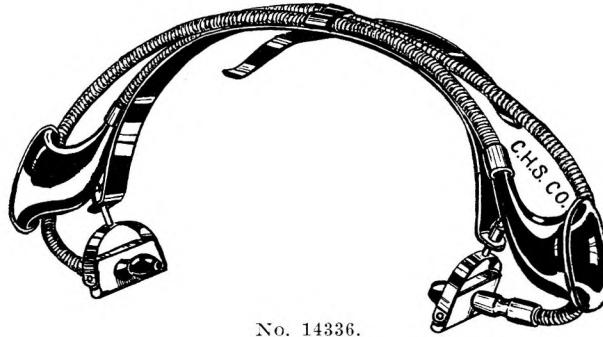

No. 14336.

Number		Price
14336.	<b>Pseudophone, Young's (P.T.)</b> This is a device for the study of direction of sounds by the human ear. The original pseudophone devised by Thompson used reflectors whereas this improved device consists of a head support carrying a sound-proof tube from one side of the head to the other so that the opposite terminal which is supplied with a receiving trumpet and an olive-shaped ear piece may be inserted in the meatus, thus artificially reversing the origin of the sound. In addition to this, the apparatus also reverses the normal time-difference between stimulation of right and left ears. It can be easily shown that the apparatus also reverses the phase-difference between right and left ears and further that it reverses the binaural intensive ratio. Consequently, right-left reversal of localization is to be expected from the standpoint of any one of the leading localization theories. The apparatus is carefully constructed with tubes of precisely equal length and each terminal is supplied with a heavy sponge rubber pad so as to prevent leakage, friction, and inconvenience while the device is being worn. (J.o.Ex.P., Dec. 1928:399-429).....	\$ 45.00
14355A.	<b>Audiometer, Musical Touch, Seashore and Wickham.</b> Same as No. 14355 but with converter so that it can be used on the 110-volt D.C.....	120.00
14605A.	<b>Tonoscope, Seashore's.</b> Similar to No. 14605 but supplied with a converter so that it can be used on the 110-volt D.C.....	346.00
14618B.	<b>Lamp, Incandescent, 50 Watt, for No. 14618 Metfessel and Tiffin Phono-Projectoscope.....</b>	.75
14619.	<b>Phono-Projectoscope, Ford's.</b> A modification of the Metfessel and Tiffin apparatus. It consists of three units and is designed for use on the 110-volt A.C. It comprises a special source of light, a transmitter and a revolving drum carrying mirrors in place of the white screens used on No. 14618. (50:X13).....	158.00

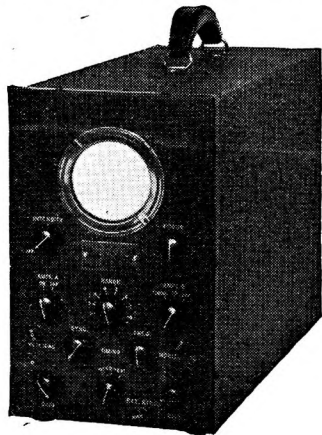

No. 14620.

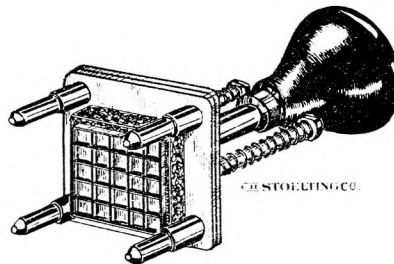

No. 18074

14620.	<p><b>Oscillograph, Cathode Ray.</b> Complete in every essential requirement for immediate use. It includes two power supplies (one for the Cathode Ray Tube, and one for the amplifier), vertical and horizontal amplifiers, saw-tooth frequency generator and six tubes, including the 3 in. RCA-906 Cathode Ray Tube. Through the use of two wide-frequency-range high-gain amplifiers, the sensitivity is guaranteed at 2 volts D.C. per inch for both vertical and horizontal deflection. The amplifiers have flat frequency characteristics between 20 and 90,000 cycles <math>\pm 10</math> per cent. The amplifier gain is approximately 40. A linear saw-tooth frequency oscillator with a special synchronizing circuit is an integral part of the oscillograph. The frequency range extends from 20 to 15,000 cycles and permits the examination of a single cycle up to 15,000 cycles or the examination of six cycles up to the limit of the amplifier—90,000 cycles. Suitable switching is provided so that either the internal timing oscillator or an external source of frequency may be connected to the plates through the amplifier. The binding posts may be connected directly to the plates for operation above 90,000 cycles with a sensitivity of 75 volts per inch. Two screwdriver adjustments are provided for centering the beam on the fluorescent screen. This may be required because of changes in geographical location or variations in tubes and circuit constants. The apparatus weighs approximately 39 pounds, and is approximately 12¼ in. in height, 7⅝ in. wide and 17¾ in. long. Additional details upon receipt of request.....</p>	84.50
--------	---------------------------------------------------------------------------------------------------------------------------------------------------------------------------------------------------------------------------------------------------------------------------------------------------------------------------------------------------------------------------------------------------------------------------------------------------------------------------------------------------------------------------------------------------------------------------------------------------------------------------------------------------------------------------------------------------------------------------------------------------------------------------------------------------------------------------------------------------------------------------------------------------------------------------------------------------------------------------------------------------------------------------------------------------------------------------------------------------------------------------------------------------------------------------------------------------------------------------------------------------------------------------------------------------------------------------------------------------------------------------------------------------------------------------------------------------------------------------------------------------------------------------------------------------------------------------------------------------------------------------------------------------------------------------------	-------

## PHONETICS

Number		Price
17096S.	<b>Rating Sheet</b> , Blanton and Stinchfield. For complete speech measurements Nos. 2-5. Used when Test II under both measurements is omitted and it is still desirable to compute the speech index. Per 25.....	\$1.25
17105S.	<b>Speech Test, Handy-Pack</b> , Stinchfield's. A very convenient and reliable speech test, consisting of 61 cards of approximately 3x5 in. This set is divided into four series—A, B, C, D. Series A consists of a set of 50 cards on which are listed all the consonant and vowel sounds in English, according to the International Phonetic Alphabet. The name of the object, the dictionary spelling and the phonetic symbol are given on the back of the card, and a picture stimulus is given on each card as an aid in eliciting the desired sound. Series B consists of 14 of the cards from Series A, numbered from I to XIV with pictures which represent the sound which gives especial difficulty to paralytics and to many aphasics. Series C contains 5 cards for testing visual and auditory memory span in a series of words ranging from 2 to 6 on a card. Series D is a series of digits for use in testing the visual or auditory memory span. The 6 cards contain from 2 to 7 digits. Instructions for administering and evaluating accompany each test .....	5.00
17106S.	<b>Score Sheet</b> . For Series A, Speech and Articulation Test No. 17105S. Per 25.....	.50
	Per 100 .....	1.50
17107S.	<b>Score Sheet</b> . For Series B, Speech and Articulation Test No. 17105S. Per 25.....	.50
	Per 100 .....	1.50
	<b>N.B.</b> The pictures in Series A, with few exceptions, parallel the objects contained in the object-test No. 17002S, previously published by the author of this test. It is often convenient and desirable to supplement the pictures with the objects and vice-versa. In working with aphasics and dyslexia cases, the two may be used in this way for reeducation and building up of associations, as the subject may see the printed word (on back of card), the pictured object representing the same, and may then pick out the object itself from the collection of objects.	
17120.	<b>Diagnostic Reading Examination</b> , Monroe's. This reading test of 12 charts (including sample), supplying all the letters, digits, syllables, and words in the various combinations and positions, was evolved by Dr. Marion Monroe in the task of putting to a critical test the theory held by Dr. Samuel T. Orton that many cases of reading disabilities in children were not due to a general mental defect nor to a congenital brain defect, but, briefly stated, to a failure in training the brain to work exclusively from the leading or dominant hemisphere. The diagnostic and remedial work carried on by Dr. Monroe at the Illinois Institute for Juvenile Research for uncovering this special kind of reading defect, attracted the notice of those interested in remedying reading defects and created such a demand for the test it was turned over to us to relieve the Institute of the expense and labor involved in making it available.  The Iota Word Test comprises Charts I, II and III; the Recognition Test, Chart IV; the Recognition of Orientation, Chart V; the Number Reversal Test, Chart VI; the Discrimination Test, Charts VII, VIII, IX, X, XI and XII. The supplementary material of Gray, Haggerty and Monroe may be obtained from the publishers. (For the Terman or Stanford Revision of the Binet and Simon test and Handedness-Eyedness tests see pages 12, 13, 174 and 175 of the 1930 edition of our catalog and pages 3 and 41 of this supplementary catalog).....	3.75
17120A.	<b>Manual</b> , Monroe's. For the No. 17120 Diagnostic Reading Examination.....	1.00
44026.	<b>Record Blanks</b> , Monroe's. For the No. 17120 Diagnostic Reading Examination. Per 25.....	2.25
	Per 100 .....	6.75
17216B.	<b>Relay, Voice Key</b> . An improved type of relay, designed to replace the No. 17216A. Useful for operating the No. 17216 Dunlap Voice Key, in connection with the No. 20219 Stop Watch Controller, or the No. 20155 Bergstrom and 20255 Klopsteg's Chronoscope.....	22.25
17220.	<b>Voice, Key</b> , Boder's. A comparatively inexpensive device, mounted in the mouthpiece of a small megaphone about 11 in. long. Used with the Darrow Behavior Research Photopolygraph, No. 24208. See pages 27 and 28 for illustration. Complete on rod, with connections, a right-angle clamp and tripod support.....	12.50

## CUTANEOUS SENSE

18025A.	<b>Rack</b> , Metfessel's. Designed for holding the Hill Modification of the Binet and Buzzenet Aesthesiometer, No. 18025. (12S:15; 12SA).....	4.50
18074.	<b>Stamp, Precision Cross Section</b> , Boring's. Very much superior to the ordinary rubber stamp used for experiments in cutaneous sensation. The air-cushion stamp of this apparatus is mounted on a stage that moves vertically upon the four legs of a small "table." The stamp itself is 2 cm. square, ruled off in 2 mm. squares. The only type of stamp that will prove satisfactory for uneven surfaces. (265A).....	20.00
18108A.	<b>Limn Gauge</b> , Boring's. Devised for finding pressure and pain limens with a variable intensive stimulus that would be more convenient than the von Frey limen gauge. It consists of a brass tube, 153x13 mm., with a thin steel rod running vertically through holes in the center of the brass plugs at the ends. The rod is supported within the tube by a spring which acts as a compression sleeve when in a vertical position with the weight of the rod placed upon it, and as an extension sleeve when in the same position with the rod pressing against a solid substance. A pointer projecting through a slot in the side of the tube registers the position of the rod on a scale calibrated from 0 to 10 grams in .5 gram divisions. When the gauge is used for pressure, it is used with the small brass sleeve carrying a projecting hair which is fitted upon the lower end of the rod. For pain, the hair tip is replaced by a needle. (Quar. Jour. Exp. Physiol. 1916, Vol. X, No. 1 :14).....	40.00

**KINAESTHETIC, STATIC, AND VISCERAL SENSES**

- 19013A. **Weights, Discrimination.** Metfessel's modification of the No. 19013 Fernald weights lettered "Epicanthus." The series comprises weights of 40, 44, 48, 80, 84, 88, 120, 124, 128 and 132 grams. (128A)..... \$ 12.80
- 19019A. **Rack,** Metfessel's. For the use of the No. 19019 Gilbert and Whipple Discriminating Weights. (128:16; 128A) ..... 4.50



No. 19038.

- 19038. **Algesimeter, Head's.** A metal tube about 15 cm. long, closed at the top with a needle projecting from the lower tapered end. The tube contains a fine steel rod, to one end of which is attached the needle. A fine spiral spring is attached to the blunt end of this rod and the other end of the spring inserted in a small bar which projects through a slit in the tube. The arrangement of the spring is such that it exerts no traction on the needle when the collar is at the highest point of the slit, and then if the needle is applied vertically, the point of the needle bears only its own weight. If, however, the collar is slid down toward the point of the needle, tension is put on the spring and it exerts an increasing pressure on the needle. A graduated scale indicates the pressure, in grams, exerted on the needle when the collar stands at the different points of the scale. (Stud. in Neur. I:19)..... 45.00

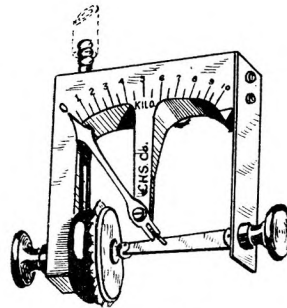

No. 19107.

- 19107. **Dynamometer and Dynamograph, Finger, Scripture's.** Designed by Scripture for establishing scales of volition in the thumb and finger grip. (193:215-224; 195:79-88)..... 25.50
- 19111A. **Dynamometer, Collins'.** An oval frame dynamometer similar to the No. 19111 but smaller in size for use with children..... 13.00

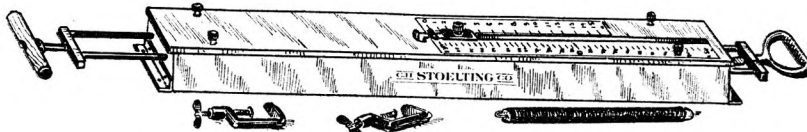

No. 19224A.

- 19224A. **Dynamometer, Reymert and Scripture.** Devised for testing, without the aid of vision, the delicacy of various degrees of muscular tension, and the perception of the extent of the push and pull movements. This is a combination of the so-called Reymert "Tensiometer" and the Scripture Dynamometer. Two interchangeable springs are furnished with each dynamometer. The springs may be readily changed by removing the four thumbscrews holding in place the slotted cover carrying the scales.  
 The spring used on the push experiment registers on a millimeter scale graduated to 140 mm. on each side of a central zero, giving roughly a range of less than 500 grams to a little over 1750 grams. A pivoted lever projecting from one end of the casing provides a stop for the central zero of this scale. The stronger of the two springs is the pull spring. This one is supplied with a metal scale graduated from 0 to 15 kilo in tenths of a kilo. An unattached slider, operating in a slot between the scales, serves to register the maximum movement. A pair of table clamps are supplied with each dynamometer. (J.o.A.P. Aug. 1929; 1924:223-227)..... 50.00

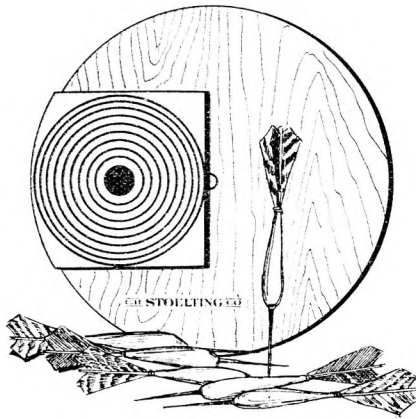

No. 19225A.

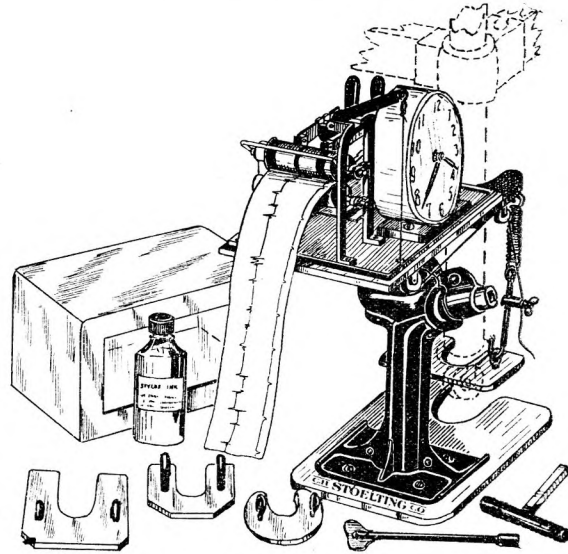

No. 19575.

Number	Description	Price
19225A.	<b>Dart Test</b> , Banister's. A test for hand and eye co-ordination. The individual throws darts from a distance of 2.5 M. at a target placed eccentrically on a phonograph table revolving at the rate of 50 R.P.M. The darts are held in the left hand and one of them thrown with the right at every revolution. Speed of throwing and rate of R.P.M. may be varied. Mounted on target with set of 6 darts. (J.o.G.P. 2, 1929:353-360; J.o.G'c.P. 38, 1930:450-458; A.J.o.P. July 1931:515, 516; 111:XS2A).....	\$5.20
19245A.	<b>Pursuit Apparatus</b> , Seashore and Koerth; Metfessel's modification. For use on phonograph (128:11; 128A) .....	30.00
19245B.	<b>Pursuit Meter</b> , Renshaw and Weiss. Made to order only (241:X32).	
19245C.	<b>Pendulum Pursuit Meter</b> , Miles'. Made to order only. (241:X32).	
19268.	<b>Habit Interference Test</b> , Metfessel's. Consisting of a pack of cards, and a distributing card with hearts in the upper left hand corner, spades in the upper right hand corner, diamonds in the lower right hand corner and clubs in the lower left hand corner. (128:101; 128A).....	2.25
19519A.	<b>Knee Jerk Apparatus</b> , Ford's. Complete with recording apparatus. (50:X8).....	95.00
19532.	<b>Ataxiometer</b> , Miles'. Made to order only. (241:X6; Jour. of Indus. Hyg. Feb. 1922:316-331)....	190.00
19533B.	<b>Ataxiagraph</b> , Gregg's Modification of Kline's No. 19533. Designed to obtain a central record and a series of 12 peripheral records 3 inches apart and 3 inches from the central record. The records are made with red ink by 2 ruling pens tracing on glazed paper. The pen supports are constructed so as to permit putting either one or both pens in or out of action at will, and making possible 30 degree shifting of the peripheral pen on the circumference of its radius. In order to reduce weight, the cap is supplied with an aluminum plate for holding the recording paper. This modification of the ataxiagraph has the advantage of supplying a number of peripheral records in addition to the central record, and, besides, reduces the weight of the writing platform and eliminates the mussy operation of smoking the paper, and the subsequent operation of fixing.	
	The price does not include the accessories such as a revolving platform for the subject, the cushioned platform for the experimenter, the curtains and their supports, the blindfold, the support for the ataxiagraph, the phonograph record, loud speaker and phonograph. We shall be very glad to quote upon request on any or all of these accessories for preventing distraction and localization of directions of voice and other sounds. Ataxiagraph only.....	19.00
19575.	<b>Hypnograph</b> , Stanley and Tescher. This apparatus was devised at San Quentin, California, for the purpose of recording the number and time of the movements made by an individual while in bed. The recording apparatus is mounted on a jack from which is suspended, by means of coil springs, a stirrup for taking one of the legs of the head of the bed. When the patient makes any movement such as turning over, moving an arm, or shifting position the action is transmitted by means of an ink stylus to the recording apparatus. The clock which propels or actuates the recording paper also checks off by means of an ink stylus 15 minute intervals. This apparatus may be used in assisting the physician in determining the affects of various drugs and narcotics on the movements made by a patient during sleep. The physician on his morning round can inspect the actogram and may graphically see the conduct of the patient during the night. (Med. Jour. & Record, Dec. 16, 1931).....	70.00



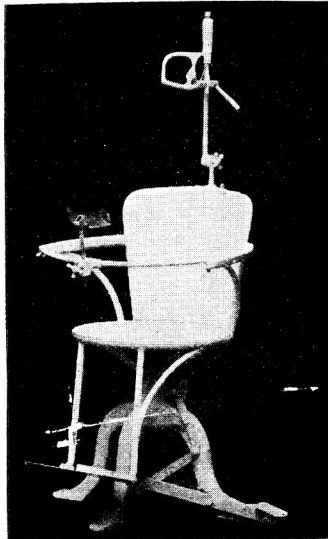

No. 19710.

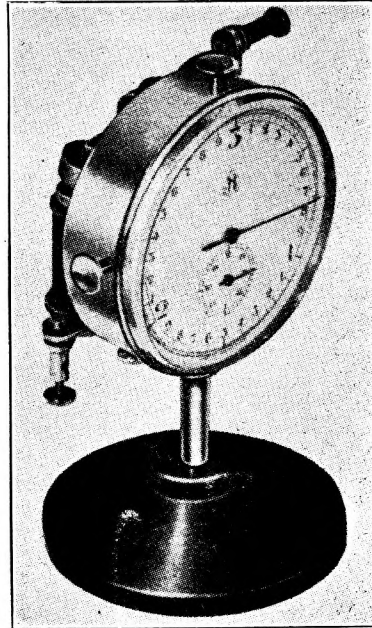

No. 20229C.

Number		Price
19710.	<b>Barany Chair</b> , Jones' modification. This chair is indispensable for the study of nystagmus after stimulation of the ear, the differential diagnosis between ear lesions and brain lesions, and intracranial localization by a study of the Barany pointing reactions. This chair is provided with a frontal cross-bar with a rest for the head in a forward position—in addition to the back headrest—thus providing for every conceivable position of the semicircular canals for testing. A handle for rotating the chair is placed just above the back headrest, making it easier to rotate and avoiding interference with the arm in making the pointing test. The chair rotates on ball bearings and is supplied with a simple and effective stopping apparatus. (50:X15; 102A:233-248; 128:19; 128; 241:X5).....	\$167.00
19710A.	<b>Ear Douche Bag</b> with drain; rubber. For use in caloric test. This is the improved Barany type. (50:X15) .....	9.00
19710B.	<b>Cut-Off</b> with graduated metal nozzle, for caloric test. Improved Barany type. (50:X15).....	3.75
19710C.	<b>Noise Apparatus</b> , Barany's. (50:X15).....	13.50
19711.	<b>Chair, Rotating</b> . An ordinary swivel office chair modified to meet the requirements of a simplified Barany chair. (128:19; 128A; 241:X5).....	39.00
19711A.	<b>Target</b> , Metfessel's. For pointing; used with the No. 19711 rotating chair. (128:20; 128A).....	1.00

**TIME AND RHYTHM**

20212.	<b>Stop Watch</b> . A stop watch on the order of the No. 20211 with side slider, but made with a push pivot in place of the slider.....	16.70
20216.	<b>Stop Watch</b> . Chromium-plated case. The large 2 in. dial reads to 10 seconds in .1 divisions. The small dial is provided with two series of figures. The figures of this dial are large, and the graduations well-spaced. The inside black figures from 1 to 5 indicate minutes, and the outside figures indicate a second revolution of the small hand so as to give readings to 10 minutes in 6 divisions, each division representing 10 seconds.....	25.40
20229B.	<b>Stop Watch, Laboratory</b> , Jacquet's. For operation on the 110 or 220 Volt A.C. May also be operated by hand. This is the No. 20229 laboratory stop watch, mounted with two magnets on a base. The magnets are thoroughly insulated so that even with extended use there will be no temperature disturbance of the watch. The indicator is returned to 0 electrically through the magnet, shown at the left. To operate the stop watch by hand the raising of a lever on the magnet at the right starts it, and pressure on the push button on the top of the watch stops it. In order to return the indicator to 0, the armature of the left magnet is depressed. The dial of the stop watch, like that of the No. 20229, is graduated in 1/5 seconds to 60 seconds. The small dial at the bottom has a range of 30 minutes in 1 minute divisions. The watch runs approximately 14 hours without rewinding.....	99.50
20229C.	<b>Stop Watch, Laboratory</b> , Jacquet's. For electrical operation on a direct current from 8 to 12 volts. This stop watch is designed for remote control for both starting and stopping, and is mounted on a base. The vertical and horizontal magnets used for operating are mounted on the back of the watch. The electrical control of the watch is designed for timing an interrupted performance. It is impossible to return the indicator to 0 without pressing the push button on the top of the watch. The large dial, unlike the No. 20229, is graduated in 1/100 of a second, instead of 1/5 of a second. One revolution of the indicator on the large dial is equal to 3 seconds; one revolution of the indicator on the small dial equals 2 minutes.....	142.00
20239.	<b>Chronoscope</b> , Dunlap's. With a special dial, devised to be used on the 110-volt 60 cycle A.C. The dial reads to 200 sigma in 1 sigma divisions.....	275.00

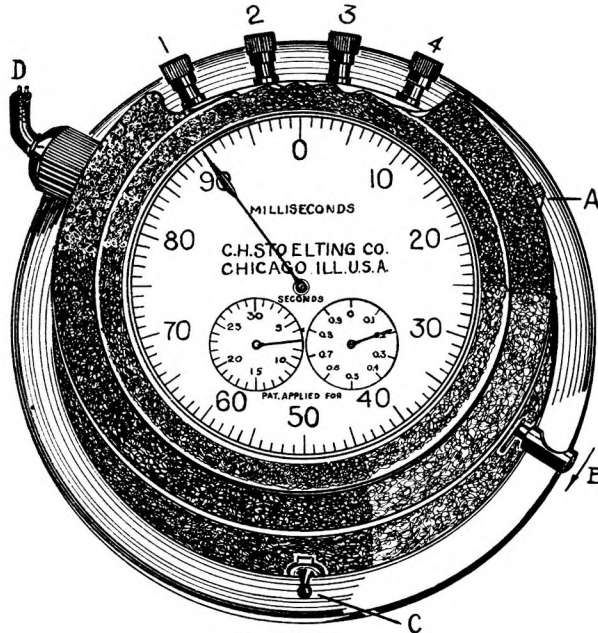

No. 20245.

Number  
20245.

Price

**Chronoscope, C. H. S. Co.** This 110 volt, 60 cycle, A.C. chronoscope represents the work of almost three years of study and experimentation in an effort to provide a timing device free from many of the objectionable features of existing timers, and the retention and improvement of their desirable features. We think our efforts have been unusually successful. We are not able to offer you a low-priced chronoscope, but we are able to offer you a compact, substantially constructed precision instrument that can be handled with impunity by the most inexperienced student, and, on the now virtually universally controlled lighting circuits, will meet the requirements of the most discriminating for research or steady use in laboratory or lecture room. It has an accuracy of  $\pm 0.001$  seconds.

The chronoscope weighs  $7\frac{1}{2}$  pounds and is entirely enclosed in a  $5 \times 7\frac{1}{2}$  in. dust-proof metal case, mounted on a base surfaced at the bottom with heavy felt. It is virtually noiseless in operation, and the negligible amount of heat generated by the motor is dissipated by an ingenious scheme of ventilation that permits prolonged operation without danger of undue heating. It will run for long intervals without oiling, the same as any good clock.

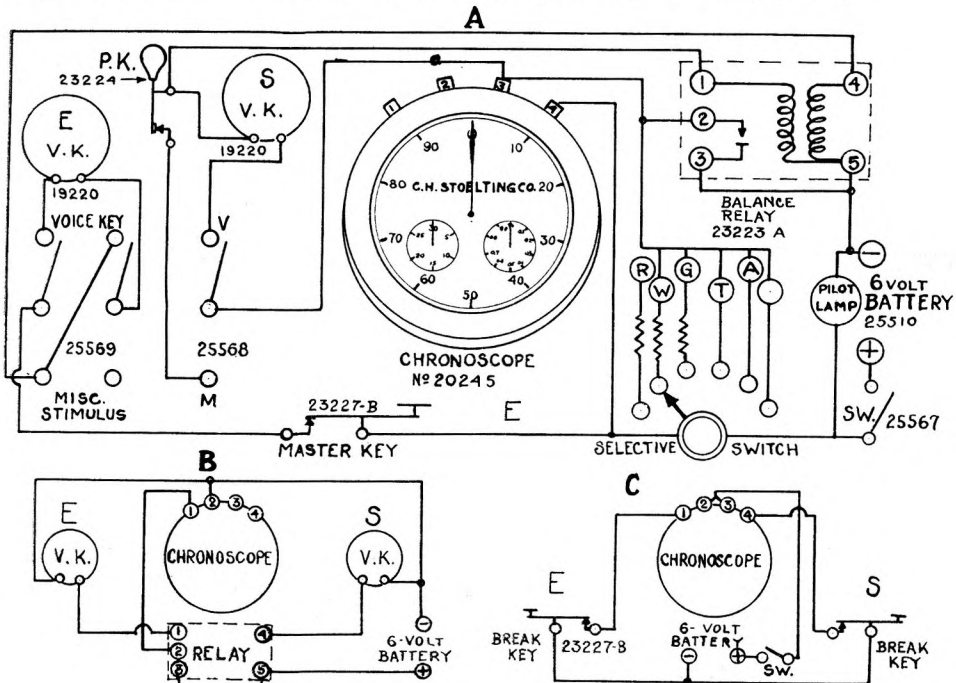

Number

Price

Among the outstanding features of this chronoscope are the ratchet tooth construction of the clutch mechanism, which eliminates slipping, the ease with which the indicators are returned to 0, and the ease with which the dials are read.

The clutch circuits (binding posts 1, 2, 3 and 4) require a direct current of 6 volts. On the preceding page will be found diagrams for various circuits. Indicators are returned to 0 by one forward pull of the lever "B," as indicated by the arrow. The large dial, 3 3/4 in. in diameter, reads in 1/1000 seconds (sigma or milliseconds); the small dial, 1 in. in diameter, at the left reads in seconds, and the small dial at the right in 1/10 seconds. In recording, take the small left dial reading first, next the right dial, and finally the large dial. The indicators in the illustration read 7, 1, and 90 respectively, that is, 7,190 sigma or milliseconds. The chronoscope is set in operation by throwing switch "C" up for starting, and down for stopping. The plug at the end of the 10 ft. connecting cord "D" is inserted in the receptacle of the 110 V. 60 cycle, A.C. lighting circuit.....

\$350.00

20265.

**Timing Disk, Stroboscopic, Metfessel's.** Required to insure proper timing of some of the Metfessel motion picture films, particularly those used for Gestalt demonstrations. Some of these films must be run at the rate of 12 frames per second instead of the standard 16 frames. A neon lamp is supplied with each disk. The price does not include mounting. The cost of the mounting depends upon the type of projector used. The timing disk and lamp only. (128A:72) .....

1.75

### EXPOSURE APPARATUS

21112.

**Card Changer, Moncrieff's.** A multiple exposure apparatus developed by Professor J. C. Moncrieff of China, to meet his requirements for a comparatively simple and inexpensive piece of equipment that he could use in his language classes. The card support and release is a rather ingenious contrivance and serves to make the apparatus a very desirable piece of equipment where a great degree of accuracy is not required.

The exposure cards used in the apparatus must be especially punched and notched to fit the support in the top of the case. When the cards are released, they fall, in order, to the bottom and can be returned to the support, without readjustment, for another series of exposures. The capacity of the support is approximately 100 cards. The area exposed is 4 in. wide and 5 in. high. The cards are dropped by a hand-lever on the left-hand side of the casing, but the operator's hand is hidden by a screen extending from the left side of the casing. A cord attached to the lever makes possible exposure from a distance. Complete, as illustrated, with a set of 100 cards.....

16.50

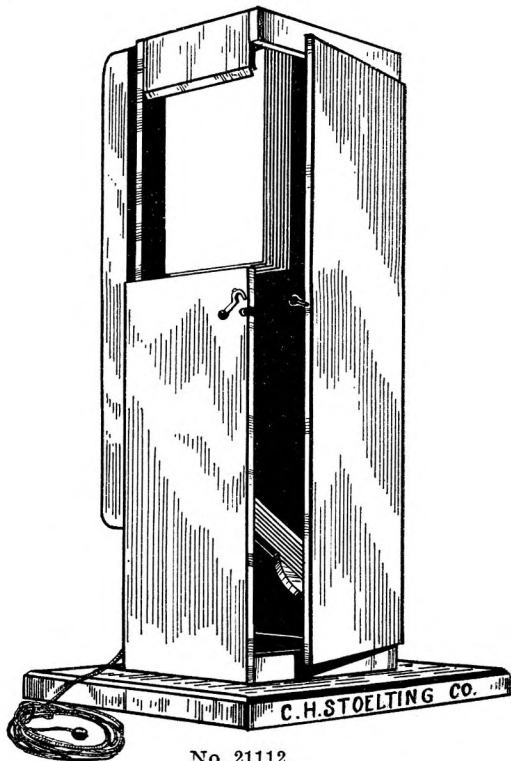

No. 21112.

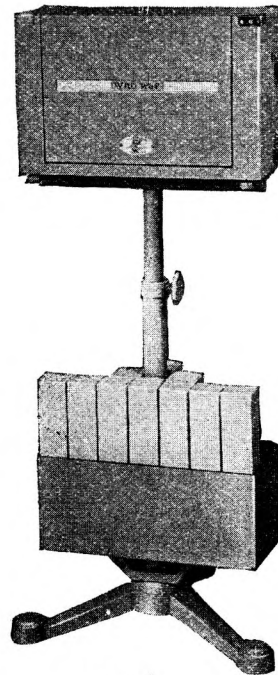

No. 21200.

Number		Price
21112A.	Cards, Exposure. For use in No. 21112 Exposure Apparatus. Punched and slotted. Per 100..	2.50
21113E.	<b>Card Changer</b> , Guhin's, electrically operated. May be used on a 110-volt A.C. or D.C. Principal advantage of this model is that the operator is not annoyed by continually keeping in mind the necessity of rewinding, necessary with the spring motor driven changer No. 21113. The spindle holds 43 cards but only 40 on an average are usable. The timing disk is graduated arbitrarily 0-140 in units of ten and gives a card range of approximately one card in .25 to 1.99 seconds .....	70.00
21135.	<b>Memory Drum</b> . University of Chicago. A heavy metal base with uprights for supporting a 5 in. kymograph drum in the horizontal position. The drum may be rotated with the hand by means of a ratchet and pawl arrangement on one side of the apparatus. A clamping device for the drum serves to hold the paper in position. The printed or other matter on the paper is shown through a shield with the required number of oblong apertures.....	112.00
21200.	<b>Metron-O-Scope</b> , Junior Model. This instrument was especially devised for individual work in the clinic for conditioning the visual apparatus to greater comfort and efficiency in reading. All the necessary provisions have been made for rhythmical control of the eye fixations, and for broadening the span of recognition or ability for visual perception of words. This is really the first piece of equipment designed to give the subject a type of orthoptic training which takes into account the accuracy and action required in reading. The instrument is very simple in operation. The operator inserts a roll of reading material, the speed dial is set at the desired point, and the motor started. The subject simply relaxes and reads an interesting story. A quietly operating triple shutter arrangement gives rhythmic exposure of each line of print in three successive sections. This procedure encourages only three eye pauses or fixations per line, and hence from one to three words are exposed by each shutter, and the eyes gradually become conditioned to broader recognition. The stimulus presented has the cohesive meaning of a story, and hence secures better co-operation of brain and eye. This instrument makes possible work with the eye, both as an organ of sight and an important factor in learning. The Junior Model is 49½ in. high, weighs 51 pounds, and requires a floor space of 20 in. square. Complete with 10 rolls of printed matter, ready for use.....	237.50

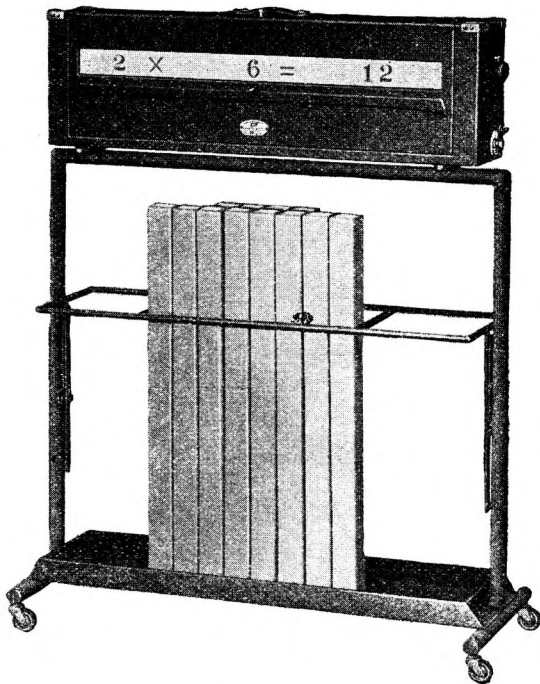

No. 21200A.

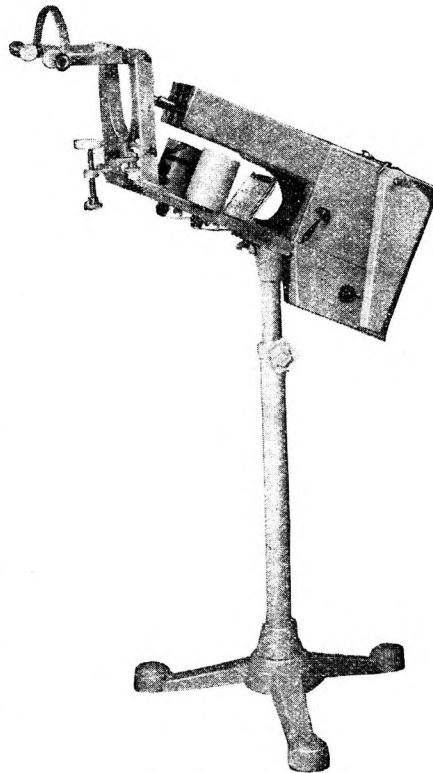

No. 21201.

21200A. **Metron-O-Scope**, Senior Model. The principle of operation is the same as in the Junior Model, but this model is larger, and designed for group work. It is 50 in. high, weighs 114 pounds and requires a floor space of 16x51 in. Complete with 12 rolls of printed matter, ready for use..... 237.50

Number		Price
21200C.	<b>Extra Rolls</b> , for Junior Model Metron-O-Scope, No. 21200.....	9.00
21200D.	<b>Extra Rolls</b> , for Senior Model Metron-O-Scope, No. 21200A.....	7.50
21200E.	<b>Record Charts</b> , for Metron-O-Scope. Size, 7½x14 in. Per pad of 50.....	.75
21201.	<b>Ophthalm-O-Graph.</b> This is an entirely new type of instrument, devised for photographically recording eye movements while reading. The operation of the apparatus is simple and interesting. While the subject is seated at the instrument, tiny light reflections from his eyes are focused on the view finder. A turn of the switch starts the film, and as the subject reads a short printed selection, the pencils of light reflected from his eyes accurately trace every ocular movement. The record obtained with this instrument is the best test of real visual efficiency, because any lack of coordination, any evidence of slow response, and any difficulty in securing the rapid consecutive fusion required in reading and study, can be readily detected and demonstrated to the subject, as the photographic records are easily interpreted. This is really the first instrument for measuring, objectively, actual visual efficiency. All orthoptic work should be checked with this instrument, as the improvement in ocular functioning, conditioned by training, always shows itself in the reading habit. This instrument is 50 in. high, 31 in. long, 11 in. wide and weighs approximately 37 pounds. It is designed for use on the 110 volt, 60 cycle, A.C.....	245.00
21201A.	<b>Ophthalm-O-Graph.</b> Same as No. 21201, but operated with an inverter, with 110 volt D.C. input and 110 V. 50 to 60 cycle A.C. output.....	\$263.50
21201B.	<b>Record Cards</b> for Ophthalm-O-Graph, No. 21201. 4x6 in., printed on one side. Per 100.....	.65
	Per 1000 .....	6.00
21202C.	<b>Tachistoscope.</b> A modification of the No. 21202, without the belt operating mechanism. It takes the place of the No. 21207 and is supplied with the exposure cards listed below.....	30.00
21206P.	<b>Exposure Cards.</b> Set of 16, perforated for use with No. 21202C. (119:X14-49, 50, 51, 52, 53, 54, 55)	1.25
21208P.	<b>Exposure Cards.</b> Set of 4. Contain figures and words for use with No. 21202C. (59:X10).....	.45
21209P.	<b>Exposure Cards.</b> Set of 5, containing various number of dots for the apprehension of number experiment. For use with No. 21202C. (59:X12).....	.60
21236.	<b>Reading Span Test, Pyle's.</b> Set of 22 cards for use with the No. 21233 Whipple's Disk Tachistoscope in studying the reading span. (Elem. Sch. Jour. Apr. 1929).....	4.40

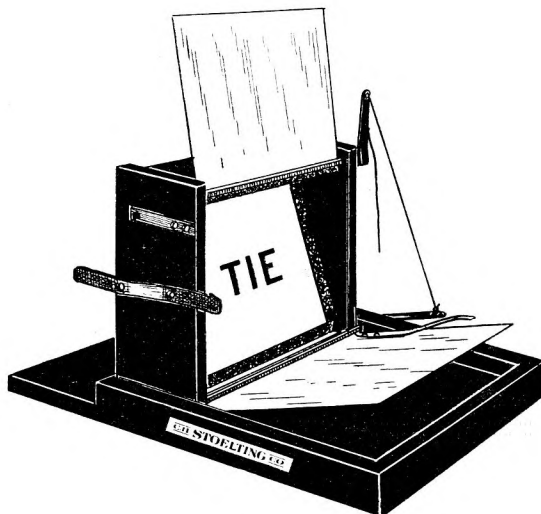

No. 21263.

21263.	<b>Tachistoscope, Falling Door Type, Weinland's.</b> A very satisfactory tachistoscope for general laboratory work. Simple and sturdy in construction, with no unattached parts to lose or delicate adjustments to get out of order. The lower door falls, exposing the material, then pulls the upper door after it, ending the exposure. Both doors compress the air into pocket cushions under them as they fall, making the operation of the apparatus practically noiseless. The tachistoscope is set with the standard exposure time of 1/10 of a second, although this can easily be varied in the laboratory if desired. Exposure material such as cards up to a size 4¼x5¾ in. can be used. Instruments of the same type, large enough to present a double-page spread of the Saturday Evening Post advertising section or special material for class demonstration, can be built to order.....	\$15.00
--------	----------------------------------------------------------------------------------------------------------------------------------------------------------------------------------------------------------------------------------------------------------------------------------------------------------------------------------------------------------------------------------------------------------------------------------------------------------------------------------------------------------------------------------------------------------------------------------------------------------------------------------------------------------------------------------------------------------------------------------------------------------------------------------------------------------------------------------------------------------------------------------------------------------	---------

## RECORDING APPARATUS

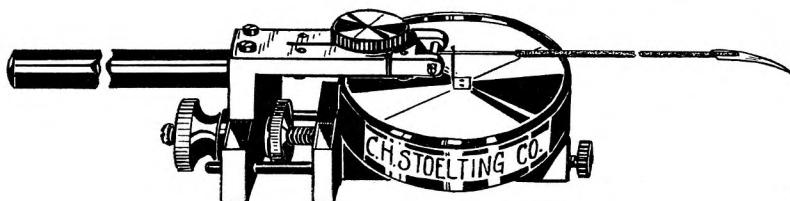

No. 22006.

Number		Price
22006.	<b>Tambour, Recording, Metal.</b> In the construction of this tambour there is used a bellows-shaped series of thin, corrugated metal capsules of a high degree of sensitivity. The capsules are protected by an encircling metal shield and the support is provided with all the adjustments common to the rubber covered Marey tambours. The use of a tambour of this type eliminates the annoyance and inaccuracies of the delicate rubber covered capsules and makes results comparable. This tambour responds promptly to variations in pressure from the receiving tambour and acquires virtually no set. The capsules are $1\frac{1}{8}$ in. in diameter.....	\$13.50
22020.	<b>Tambour, Receiving, Goggle Type.</b> Devised for recording the movements of the eyelid in winking. Both sides are provided with rubber tublatures so that a record can be made of either the right or left eye. The goggles should be used with an air valve in the pneumatic tambour circuit in order to secure the best results.....	10.00

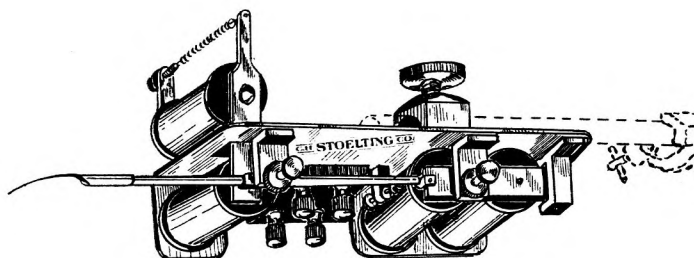

No. 22072.

22072.	<b>Recorder, Electric, Duplex, Dodge's.</b> This marker writes two non-confusable curves corresponding to two sets of experimental data, on a line with a single writing point, and thus guarantees permanent alignment and conservation of space. It was originally designed for use with a projection chronograph. It has been used to record time in reaction, stimulus and response, and two sets of reactions. It records on various smoked surfaces or plain paper with ink, and with appropriate optical additions, can be used with photographic paper and film. In all these situations and various others, it has proved itself a reliable as well as a versatile laboratory instrument. This marker may be wound for either low or high voltage. The stock marker is designed for about 1.5 amperes at 3 volts. (A.J.o.P. Jan. 1929:118, 119)....	\$ 45.00
22224A.	<b>Support Rod.</b> With fine adjustments. For use on the bracket of No. 22224 Accessories Support designed for attachment to the No. 22207, 22208, 22211 and 22212 Kymographs.....	20.00
22275.	<b>Kymograph, Students'.</b> This kymograph is the response to the demand for an inexpensive, substantially constructed, electrically operated kymograph for students' use. The base and drum support are made of heavy castings in order to insure stability and permanence, and so designed that the kymograph can be used in either the vertical or horizontal position. The kymograph is designed to operate on the 110 volt, 60 cycle, A.C. A switch on the top of the cylindrical base serves to start and stop the kymograph. At the right of the switch is an arbitrary scale graduated in 6 steps to give drum surface speeds of approximately .2, 1, 5, 10, 50 and 250 mm. per second. Complete as illustrated with 6 in. drums, and permanently attached 10 ft. connecting cord.....	\$56.00
22275A.	<b>Slow Adjustment Attachment.</b> Devised for converting the No. 22275 kymograph into a slow motion kymograph.....	10.00
22275B.	<b>Auxiliary Drum.</b> Mounted on a heavy, adjustable base, for converting the No. 22275 kymograph into a "long paper" kymograph.....	24.00

Number	Price
22303A. Paper, Glazed, for kymograph; 21½x6¼ in.; ungummed on edge. Per 100 sheets.....	\$ 1.00
22303W. Paper, Recording, waxed surface, 21½x6¼ in., for 6 in. drum. Per 100 sheets.....	2.30
22304W. Paper, Recording, waxed surface, 21½x10 in., for 6 in. drum. Per 100 sheets.....	4.00
22305W. Paper, Recording, waxed surface, for 6 in. drums. Per roll of 100 M.....	4.00
22306W. Paper, Recording, waxed surface, for 10 in. drums. Per roll of 100 M.....	6.00

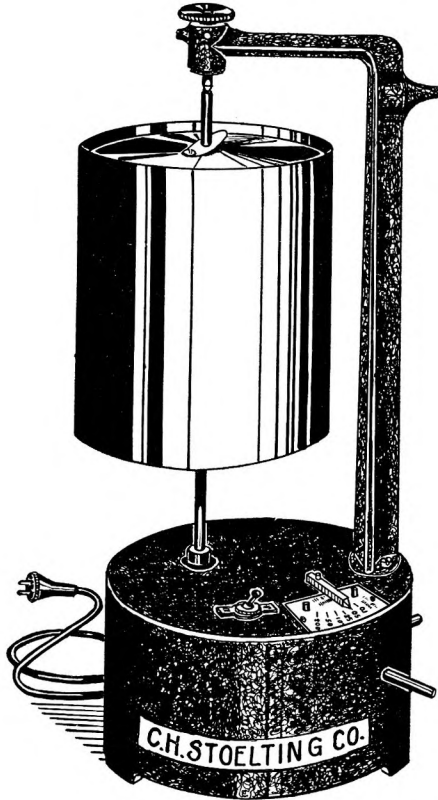

No. 22275.

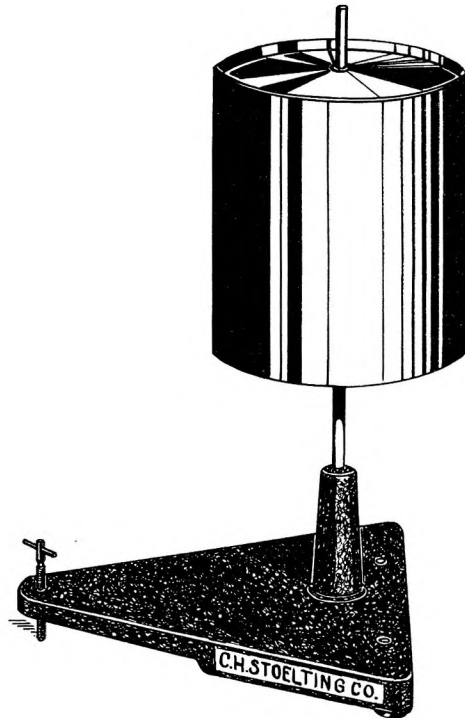

No. 22275B.

- 22329. Support, Tuttle's.** This support was developed at the Medical School of the University of Iowa, and meets all the requirements of an efficient and substantial device for the fixing of the belt records of the long paper kymographs. The distance between the large 10 in. drum, 6 in. in diameter, and the small 10 in. drum, 2 in. in diameter, can be varied from approximately 30½ in. to 44 in. The large drum with the crank at the top of the support may be raised or lowered through a range of 13½ in. The rod carrying the drums is nicely balanced by a spiral spring which, when released, automatically carries the lower drum, with the upper drum, out of the fixing bath. The rod carrying the drums has a vertical movement of approximately 4½ in. The small drum at the bottom is pivoted and by means of the crank at the right, may be turned through a radius of 2½ in. This movement permits the application of sufficient tension for tightening or loosening the paper belt, preparatory to fixing or removing it for drying. The illustration shows how the support may be used in connection with our No. 22326, or an ordinary metal or glass dish. While not intended to replace the kymograph, it, nevertheless, is possible to use the support as a hand-driven long paper kymograph ..... 40.00
- 22405. Timer and Counter, Electric.** A modified Ewald chronoscope of very rugged construction. It is designed for both timing and contact recording. It can be operated for timing on the 110 volt, 60 cycle A.C., with the aid of an adjustable transformer for stepping down the voltage to a range from 11 to 16 volts, or by means of an electrically maintained tuning fork. The outside circle of the 2 in. dial, the one used for timing, is graduated in 120 divisions and numbered every 10. One revolution of the indicator is equal to one second, when operated on the 110 volt 60 cycle A.C. The inner circle of the dial is used for recording contacts. It is graduated in 100 divisions, and like the outside circle, is numbered every 10. The instrument is mounted on a 5x7 in. metal base, which is supplied with a combination switch and push button for continuous or intermittent operation. The indicator is returned to zero by short, light taps on the combination button..... 27.50
- 25600. Transformer, Toy, Adjustable.** For use with the No. 22405 Electric Timer and Counter. Reduces the 110 volt 60 cycle A.C. to a voltage ranging from 11 to 16 volts..... 2.50

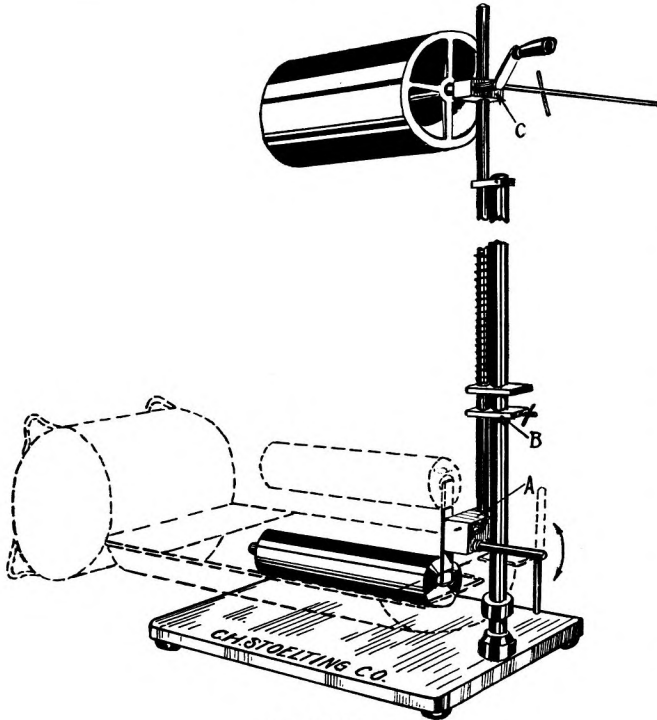

No. 22329.

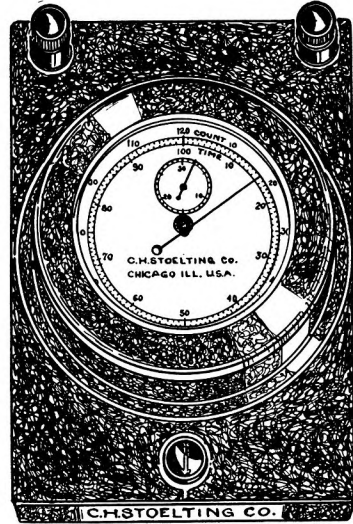

No. 22405.

Number

Price

**22480. Polygraph, Laboratory, Mooseheart.** Developed in the Mooseheart Laboratory for Child Research under the direction of Martin L. Reymert, Ph.D., from designs furnished by Harold A. Kohn, Research Assistant in Psychology, and executed by Andre Espitallier, expert mechanician. This polygraph contains a number of new and very practical features. It is powered by a variable speed motor of 1/20 h.p., virtually free from vibration. It is stepped down in a 6 to 1 ratio by making use of gearings built into the motor, and it is stepped down further in an approximate ratio of 84 to 1 by means of an external worm and gear. A fair constancy of speed is maintained by means of a fly type governor and changes in speed are effected by a rheostat with an arbitrary calibrated dial, instead of gear shifting. No external battery of any kind is necessary. The apparatus is designed for use on the 110 volt 60 cycle alternating current.

Three inexpensive fountain pen and pencil combinations, electrically operated, serve to make the tracings. With this combination it is possible to obtain either a temporary pencil record or a permanent ink record by simply reversing the pen and pencil combination. Independent electrical action of all three pens is secured by a simple system of magnets and levers. The magnets, when actuated by the closing of switches, bring a set of shoes into contact with the drum, which is simply an extension of the worm. These shoes actuate the levers operating the pens. The shoes are so designed that the surface which comes in contact with the drum forms a perfect arc, the center of which is the axis of the pin on which the shoes are hinged. The paper carrier is attached to the rear of the polygraph. It carries a roll of paper 5 in. wide and approximately 450 ft. long. The tension of the paper is regulated by means of a simple thumb-screw.

Among the numerous advantages of the polygraph are the following: (1) easily portable; weight, approximately 25 pounds. (2) No source of current other than the regulation 110 volt 60 cycle A.C. necessary. Self-contained transformer for reducing current to a range of 8 to 24 volts. (3) Inexpensive combination fountain pen and pencil for recording. (4) Unusual sensitivity to action. (5) Rapidity with which change of paper is effected. (6) Adaptability to almost any type of experimental procedure, such as tapping rate, steadiness recording, reactions, lip or voice key operation, etc. (7) Independent amplitude regulation for each pen. (8) Paper movement may be promptly arrested at any point without stopping the motor. (9) Means for instant change of recording amplitude.

There are very few experimental techniques which cannot be recorded by means of this apparatus. This apparatus is designed for 3 pen operation, i.e., constant time line, single stimulus line, and response line. If more than 3 variables are to be recorded we can, at a comparatively small advance, increase the number of pen and pencil combinations to suit the needs of any particular experiment.....

\$150.00

- 22480A. Fountain Pen and Pencil Combination..... .50
- 22480B. Paper, for No. 22480 Polygraph; 5 in. wide, 450 ft. long. Per roll..... 1.25



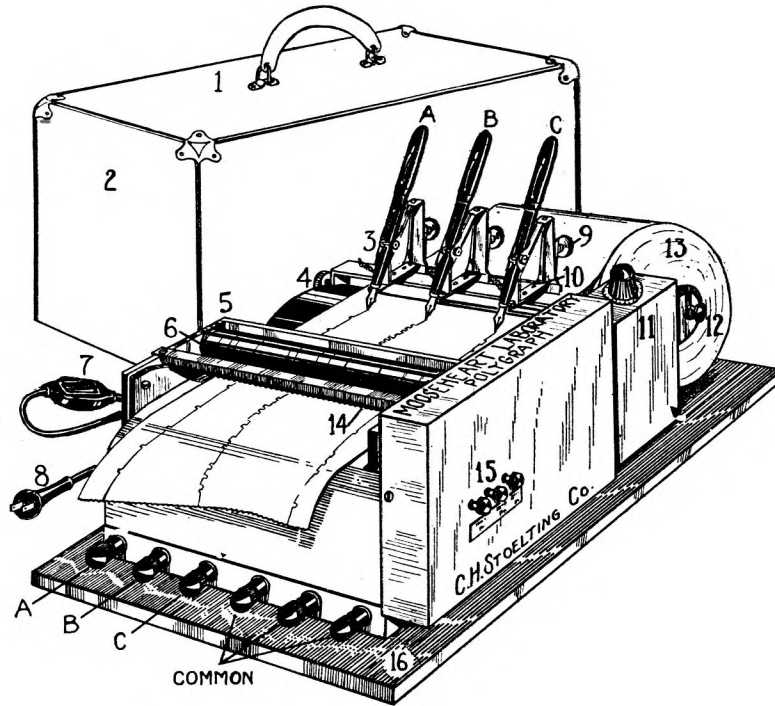

No. 22480.

Number

Price

**22490. Polygraph, Cardio-Pneumo.** Designed to meet the demand for an instrument that will stand up under constant usage and produce simultaneous pneumograms and cardiograms at definite speeds, and allow the operator to promptly punctuate the start and termination of an observation or action period. An instrument of this type can be used by the psychologist for the study of the emotional effects indicated by blood pressure, respiration and response time; the physician will find the instrument useful in studying blood pressure, pulse and respiration. The entire internal pneumatic mechanism is of air-tight metal construction; the only rubber used is the external rubber tubing required for connecting the subject to the instrument, and the pressure bulb used by the operator and the subject for actuating the pneumatic punctuating or indicating devices.

The polygraph is readily portable, as its weight is somewhat less than 17 pounds, and the  $8\frac{1}{2} \times 9 \times 13\frac{1}{2}$  in. carrying case is supplied with a handle.

One of the outstanding features of this instrument is the arrangement for preventing damage to the stylus carrying the blood pressure recording pen. In most of the instruments of this type, there is no means for satisfactorily controlling the excursions of the pen while the bandage is being inflated. The moment the operator starts to pump up the inflatable bandage, the high pressure causes the pen to fly back and forth and damage the stylus by bending it, to say nothing about spilling the ink from the pen over the recording paper. This objectionable defect is entirely eliminated by means of the central stylus mechanism which gives a continuous record of the pressure with which the operator is working. For example, should he desire to work with a mercury pressure of 80 millimeters, he simply inflates the sleeve until it registers 80 on the pressure gauge. This middle indicator will then show an almost straight line, indicating the 80 millimeter pressure. In the event that a change in pressure should be desired, it can be readily accomplished by moving the panel indicator to "inflate or deflate" and then increasing or decreasing the pressure, by means of the bulb, to the desired amount. This middle indicator then begins recording at the new level. When the pressure has been brought to the desired amount, the panel indicator is again turned to "record." This shuts off the high pressure compartment and, without further adjustment, puts into action the pen for recording the relative blood pressure and the pulse.

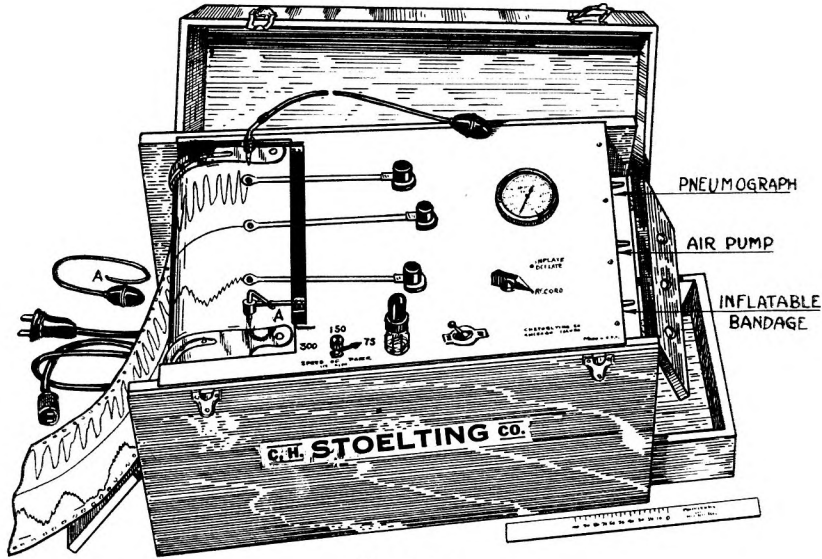

No. 22490.

Number

Price

A transparent celluloid scale, graduated in millimeters of mercury, graduated for each individual instrument, is supplied for reading the fluctuation of the blood pressure. An eccentric wire stylus protector serves to raise the pens from the paper and protect them while in transit. As a safety precaution, it is always advisable to close the valve on the inflation bulb, and close down the pinch cock on the air line. In order to deflate the bandage, turn the panel indicator of the air cock to "inflate or deflate," unscrew the pinch cock on the rubber tube connecting the inflating bulb to the apparatus, and release the valve on the inflating bulb. This device for keeping the blood pressure pen out of the recording circuit while pumping up the bandage to the desired pressure, adds considerably to the convenience and life of the apparatus. Never disconnect pressure bulb from instrument while in use.

The synchronous motor drive for the paper is geared to give paper speeds of 75, 150, and 300 millimeters per minute. The apparatus is designed for operation on the 110 volt 60 cycle A.C. only. No auxiliary batteries are required for operation. It is merely necessary to plug into the ordinary 110 volt 60 cycle A.C. lamp socket.

The recording paper is 6 in. wide, with a clear recording space of 5 in. Both edges of the paper are perforated with holes half an inch between the centers, and as these run over carefully constructed sprocket wheels, an accurate movement of the paper is insured at all speeds.

The pneumograph and sphygmomanometer bandage are attached as indicated in the illustration. The middle connection is reserved for the inflating bulb. All the tubular connections are tapered and can be slipped off and on with a slight twist. They are absolutely air-tight and not interchangeable. Accessories are listed below.....

\$300.00

(List of Accessories for 22490)

Number		Price
56231A.	Inflatable Arm Bandage.....	\$ 6.67
57111.	Pneumograph, Sumner's .....	9.25
57113.	Pneumograph, Gutzmann-Scripture's .....	6.00
57115.	Pneumograph, Verdin's .....	35.00
57117.	Pneumograph, Marey's .....	40.00
56427.	Plethysmograph, Arm, Lehmann's .....	60.00
56459.	Plethysmograph, Francke's .....	22.50
56467.	Plethysmograph, Finger, Harvard .....	.50
56607.	Cardiograph, Marey's .....	14.50
22490B.	Paper, for polygraph, 6 in. wide, perforated, approximately 90 ft. to a roll.....	1.00

REACTION

**Interference Materials, Stroop's.** These materials were developed in the laboratory of the late Dr. Joseph Peterson of Peabody College, and furnish a new and convenient method for studying interference; thus permitting this important subject to be added to the experimental list of courses in General and Experimental Psychology. As supplementary equipment, only a stop watch and compartment box are required. The procedure is that which is common to the laboratory. Varying degrees of interference may be studied by varying the practice in the materials used. The tests are individual and include materials for both verbal and muscular reactions. (J.o.EX.P. Dec. 1935:643-662).

Number		Price
<b>23005A.</b>	<b>Color-Word Interference Chart.</b> The words red, blue, green, brown, and purple are used. No word is printed in the color it names, but an equal number of times in each of the other four colors; i.e., the word "red" is printed in blue, green, brown, and purple inks; the word "blue" is printed in red, green, brown and purple inks. Thus each presents the name of one color printed in the ink of another color, hence, a word stimulus and a color stimulus (a different color) are presented simultaneously. The colors (in which the words are printed) are so arranged that each color appears twice in each line, with no regularity of occurrence, with no color immediately succeeding itself. The color names follow a similar arrangement. The chart (8½x11 in.) contains 10 lines of 10 words each printed from 14 point Franklin lower case type on heavy, soft white paper. A sample line is printed at the top of each chart. Each	\$1.50
	Per 10 .....	10.00
<b>23005B.</b>	<b>Word Chart.</b> In this chart, the word order of the No. 23005A color-word interference chart is duplicated in black ink. Each.....	.50
	Per 10 .....	3.00
<b>23005C.</b>	<b>Color Chart.</b> This chart duplicates the color order of the No. 23005A color-word interference chart in swastikas. Each.....	3.00
	Per 10 .....	20.00
	The difference in the time for reading the words of the No. 23005A Color-Word Interference Chart and that for reading the words of the No. 23005B Word Chart is the measure of the interference of color stimuli upon reading words. The difference in the time for naming the colors of the Color-Word Interference Chart and that for naming the colors in the No. 23005C Color Chart is the measure of the interference of word stimuli upon naming colors.	
<b>23005D.</b>	<b>Color-Form Interference Chart.</b> Similar in structure to the No. 23005A Color-Word Interference Chart. The same colors are used, but instead of words the following forms are used: star, circle, cross, square, and triangle. Each.....	3.00
	Per 10 .....	20.00
<b>23005E.</b>	<b>Form Chart.</b> All of the forms of the No. 23005D Color-Form Interference Chart printed in black. Each .....	1.50
	Per 10 .....	10.00
<b>23005C.</b>	<b>Color Chart.</b> This is the same chart used in the Color-Word series.	
	<b>Color-Word Interference Cards, Stroop's.</b> These cards adapt the materials used on the color-word interference charts to the study of interference in card sorting. The set consists of 3 packs of 60 cards each, the size of playing cards.	
<b>23005F.</b>	<b>Interference Cards.</b> This set of 60 cards consists of the name of each of the five colors printed on 3 cards in each of the other four colors.....	12.00
<b>23005G.</b>	<b>Word Card.</b> This set of 60 cards consists of 12 cards each of the five color names printed in black .....	12.00
<b>23005H.</b>	<b>Color Cards.</b> This set of 60 cards comprises 12 cards of each of the five colored swastikas....	12.00
	<b>Color-Form Interference Cards, Stroop's.</b> These cards adapt the materials used on the Color-Form Interference Chart to card sorting methods. They differ from the Color-Word Interference Cards by using forms in place of words.	
<b>23005I.</b>	<b>Interference Cards.</b> This set of 60 cards consists of 3 cards each of the various combinations of forms and colors.....	12.00
<b>23005J.</b>	<b>Form Cards.</b> This set of 60 cards includes 12 each of the five different forms printed in black..	12.00
<b>23005H.</b>	<b>Color Cards.</b> This is the same set used in the Color-Word series.	
<b>23005M.</b>	<b>Manual, Stroop's</b> .....	1.50
	<b>N.B.</b> We are prepared to furnish, at a slight advance in price, Form 2 of the charts on comparatively short notice.	
<b>23227M.</b>	<b>Key, Make.</b> For those who desire something superior to the No. 25511 Telegraph Key.....	6.00
<b>23301A.C.</b>	<b>Psychodometer, Chicago.</b> On the order of the direct current psychodometer No. 23301, but provided with a chronoscope having a disk graduated to 200 sigmas in 1 sigma divisions. With this disk no calculations are required. A No. 25593 rectifier and 25510 battery are supplied in place of the No. 20013 electrically maintained tuning fork, and the No. 25510A 24-volt storage battery .....	743.70
<b>23320.</b>	<b>Psychodometer, Metfessel's.</b> Devised for use with an opaque projector in classroom demonstrations on various types of muscular reactions and visual and vocal stimuli, with manual or vocal response. The psychodometer proper consists of a base on which is mounted the requisite equipment, and the No. 22405 Impulse Counter (made visible on the screen) attached by long connecting cords. The long connecting cords between base and counter facilitate placing the impulse counter on the stage of the projector so that the dial and indicator may be shown on a screen, while leaving the base board in a convenient location on the instructor's table or desk for operation during demonstrations. The psychodometer base with concealed and protected connections carries five No. 23227 keys, a No. 23223A Balanced Relay, a No. 25599 Transformer (50 watts, 50-133 cycles, 100-120 volts) giving 5.5-11.5 volts in 1.2 volt steps, a T.P.D.T. switch, two S.P.S.T. switches, a four-point radial switch, a No. 23284 three-color visual stimulus, and fifteen binding posts for connecting the accessory apparatus (not included in the price), such as the No. 17216 Voice Keys, No. 19523 Steadiness Tester, No. 19241 Tracing Board, No. 19303 Tapping Board, and No. 19245A Pursuit Meter suggested by Dr. Metfessel in his Instructor's Guide. Psychodometer base, equipped as described, and impulse counter (128A:1-10; 128R:1-3, 6-10).....	158.00
<b>23325.</b>	<b>Psychodometer, Hipp's.</b> Arranged for light and sound reactions with the No. 20241 Chronoscope for timing.....	507.00

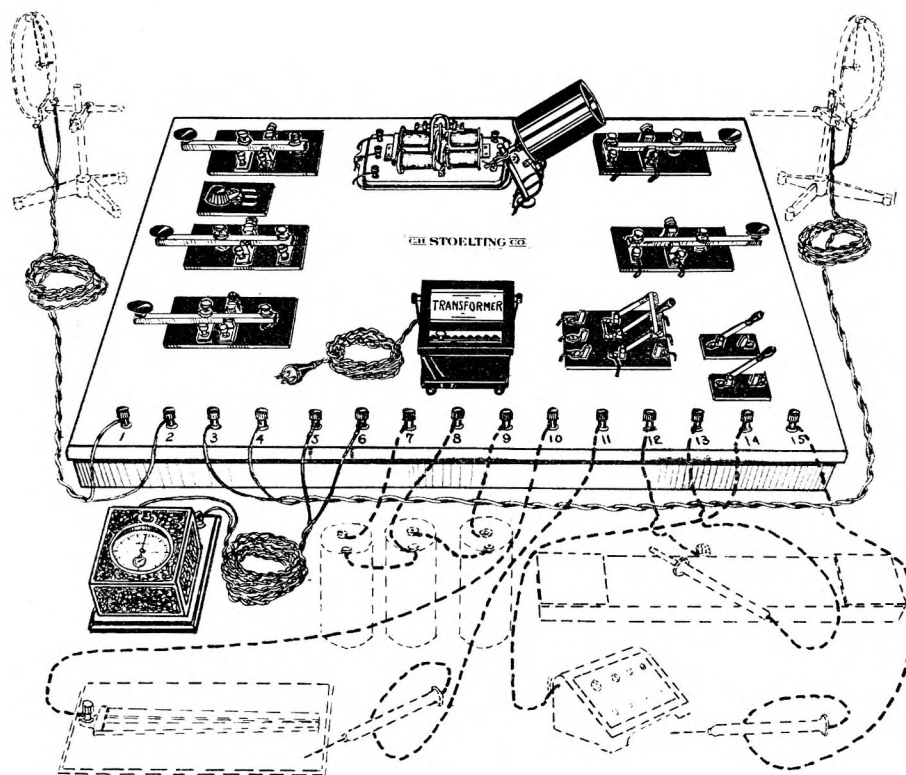

No. 23320.

**AFFECTION—FEELING—EMOTION**

Number

Price

**24201E. Current Regulator.** Designed for regulating the amount of current flowing into the No. 24201 Psychogalvanograph from an external source of current. It consists of a base carrying a 4½ volt dry battery, a direct current milliammeter, and incased variable resistance and switch ..... **\$25.00**

**24206. Psychogalvanoscope, Howell's.** A combination of what was originally an electrical stimulus apparatus, with the additional equipment required to turn the apparatus into a psychogalvanometer of the direct current type, or a psychogalvanometer of the alternating current type. This combination of three pieces of equipment in one provides a sensitive, stable, easily controlled, and capable apparatus for various types of experimentation. The functioning of this apparatus involves two distinct operations. First of all, a relatively constant current is passed through the tissues of the subject between the points of contact of the apparatus, and second, the variations in electrical potential, which are produced at these points of contact as a result of the variations in resistance of the tissues, are measured by a very sensitive voltmeter. The variations in deflection of this voltmeter constitute a measure of the psychogalvanic phenomena. Since the instrument is a voltage-operated rather than a current-operated instrument, and since practically no current is consumed in operating the voltmeter, it is possible to study the psychogalvanic phenomena under circumstances in which different quantities of current are flowing through the tissues and when different degrees of polarization exist at the points of contact. The fact that the apparatus can be used as either a D.C. or A.C. galvanometer is a distinct advantage. Each type has its advantages and is especially adapted for certain purposes. (A.J.o.P. Jan. 1931:122, 123; J.o.Ex.P. Oct. 1932:591-597)..... **155.75**

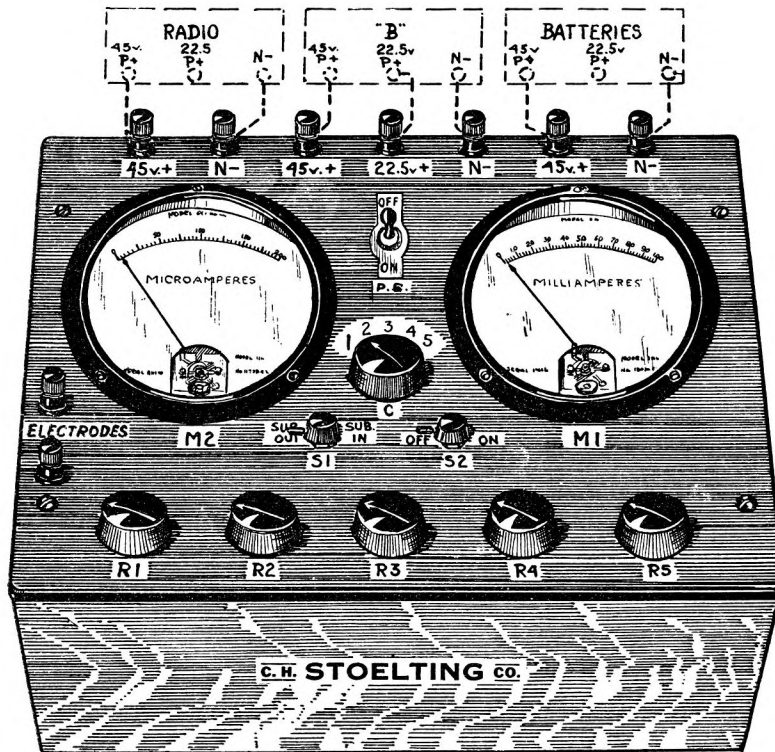

No. 24206.

Number  
24208.

**Photopolygraph, Behavior Research, Darrow's.** In the study of the emotions, it is advisable to take advantage of every physiological indicator that can be successfully harnessed for the production of graphic records. Checks on interpretation in this field are just as important as, for example, checks in the determination of visual acuity, auditory acuity, intelligence, etc. No one test or indicator may serve to lay bare all the factors necessary for reaching a conclusion. Reliance on the indications of too small a number of physiological indicators may prove misleading, and, in some cases, fail to provide anything upon which to base even a tentative conclusion.

The Darrow Behavior Research Photopolygraph gives a record of the time the stimulus word is given, a record of the time of the response or reaction word (the interval between being represented by vertical lines spaced at the rate of either two or four millimeters per second, as desired), a record of the respiration, that is amplitude and the inspiration-expiration ratio, a record of the relative blood pressure (so-called systolic) with pulse rate, a record of the psychogalvanic skin reflex (changes in moisture of the skin due to reflex action of the sweat glands and probable changes in electrical potential resulting from metabolic activities) and the two records of the tremographs; one showing a record of the tremors (toxic, organic or functional) of the non-dominant hand to which the electrodes are attached, and the other, the revealing involuntary pre-reaction movements, and the erratic movements of the dominant hand following the subject's reaction with this hand when vocalizing the response to the stimulus. The tremograph records combined with the verbal stimulus-response record provide very important data. This combination gives the phenomena observed by Luria and produces entirely different patterns for the emotionally undisturbed and disturbed, or, the innocent and the guilty. The verbal-motor reaction is supposed to be especially efficient as an indicator of conflict in the verbal reaction mechanism.

Either one of the recording tambours used for the tremographs can also be used for making other records, such as stabilometer, bed movement, abdominal respiration, gastro-intestinal balloon, plyphesmographic, carotid, or radial pulse records. The polygraph provides excellent means for studying the respiration and blood pressure in health and disease. It also permits the study of normal tremors, toxic tremors, due to tobacco, lead, alcohol, and hyper-thyroidism, the organic tremors due to brain lesion, general paresis, paralysis agitans and the functional tremors due to fear, hysteria, neurasthenia and various other psycho-neuroses. The hand tremors usually consist of vibrations having amplitudes of  $\frac{1}{16}$  to  $\frac{3}{8}$  in. and frequencies ranging between 5 and 15 cycles per second.

So far, this is the only apparatus for the study of behavior that combines in a compact and readily portable manner the best devices for making visible and recording simultaneously all the principal physiological phenomena present in deception or when the emotions are otherwise aroused. The photographic records produced by the shadowgraphic method are taken on very sensitive bromide paper  $2\frac{1}{2}$  in. wide and 175 ft. long. The paper is of sufficient length to provide 7.4 hours of recording at the two millimeter rate and 3.7 hours at the four millimeter rate. The records of the different styli may overlap to a considerable degree without appre-

Price

Number

Price

cial confusion or mutual obliteration. This gives maximum amplitude of movement for the respective styli without adding seriously to the cost of obtaining multiple records. The styli records can be easily distinguished and followed by means of their position or form and the character of the tracings.

When the record leaves the apparatus, it is ready for study, but it is advisable, if permanency is desired, to run it through the post-fixing bath as soon as possible and give it a thorough washing. In the shadowgraphic method employed in this equipment, there is no annoyance from ink-clogged pens, styli sticking or sliding on rough or slippery spots in the paper, failure of the styli to record properly on account of the piling up of wax or soot on the points, or on account of faulty waxing or smoking of the paper surfaces, defective operation of the kymograph drum or careless attachment of the recording paper to the drum. You get away from the ink, soot, and all the mussy operations incidental to gumming, shellacking, etc. The photographic process is simple, automatic, clean, rapid, and does not require anything outside of what is shown in the illustration.

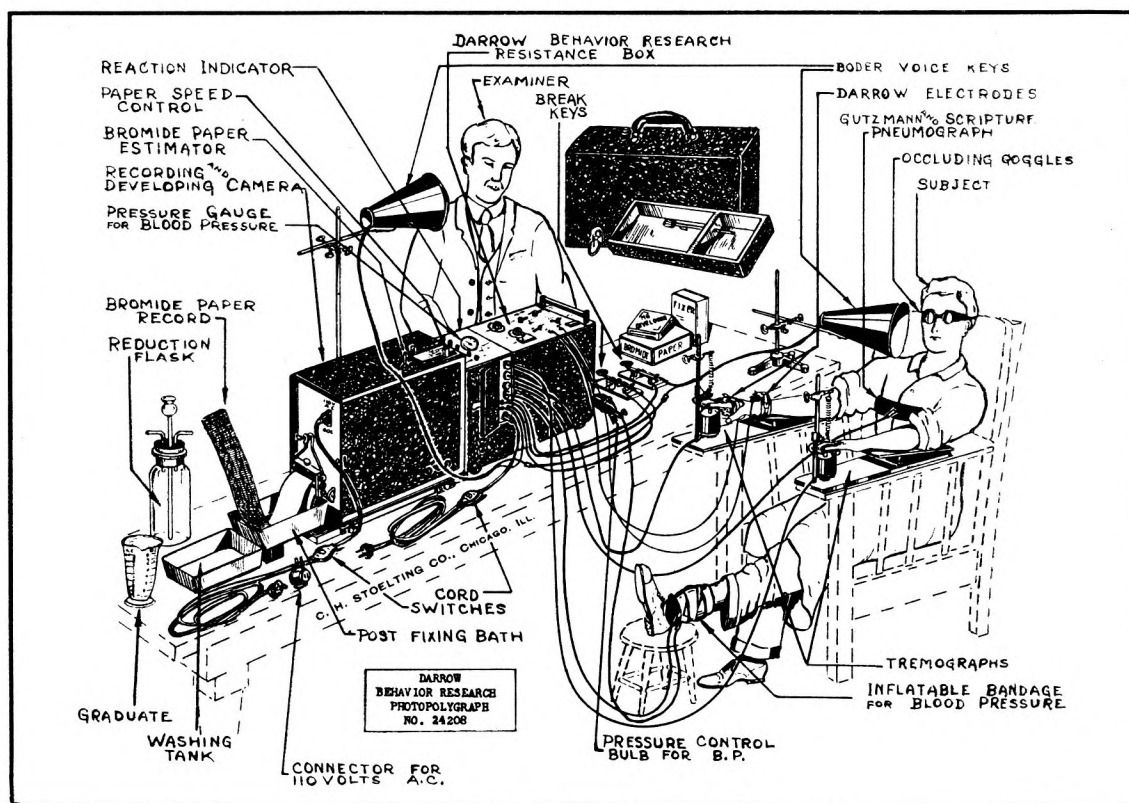

No. 24208.

The two units of the Photopolygraph are approximately the same size—namely, 6x14 $\frac{1}{2}$ x15 $\frac{1}{2}$  in. They are both portable and provided with handles. The unit at the right in the picture is the recording or reaction unit, and weighs approximately 22 $\frac{1}{2}$  pounds. It includes the timing device, the Darrow Behavior Research Resistance Box, and the sensitive galvanometer constituting the psycho-galvanic equipment, 4 sensitive compound metallic tambours (no rubber tissue used) for recording blood pressure, respiration, tremors, motor reactions, and the pressure gauge for the sphygmomanometer. The unit shown at the left carries the photographic apparatus and weighs approximately 20 pounds. The light-tight carrying case contains the motor, and other accessories for unwinding and immersing the 175 foot roll of 2 $\frac{1}{8}$  in. bromide paper in developing and fixing baths.

In the latest model of the polygraph, the pair of No. 23227 external break keys have been discarded, and with them went the more or less objectionable outside circuit required for connecting break keys and voice keys to the recording unit. The equivalent of the break keys has been incorporated in the interior of the recording unit and the circuits may be broken by means of two push buttons located in front of the pressure gauge, under the eye of the operator, and within just as easy reach of the hand as the dials and switches. The only connections now on the outside are those used for connecting the subject to the apparatus.

A valuable feature of the recording or reaction unit is the ground glass observation screen inserted in the top of the case, on the operator's right, adjacent to the line of control buttons used to keep the indicators within recording range. All indicators and their movements may be kept under constant observation by the operator. The proximity of the control buttons provides means for instant rectification of any of the 7 indicators. Last, but not least, the operator receives immediate information of what is taking place without waiting the 2 $\frac{1}{4}$  or 4 $\frac{1}{2}$  minutes required for the developed and fixed record to emerge from the photographic

Number

Price

unit. This feature, and the possibility of using the break keys on the top of the unit as markers, for identification purposes, leave nothing to be desired from the standpoint of convenience and control.

In addition to the two units described there is included one No. 56231A Inflatable Sphygmomanometer bandage, one No. 57113 Gutzman-Scripture Pneumograph, one pair of No. 19220 Boder Voice Keys, one pair of No. 19434 Tremographs, one pair of No. 24217 Darrow Electrodes, one No. 24208I respiration amplitude reducing bottle, one roll of No. 24208E bromide paper, 175 ft. long, 2½ in. wide, one No. 24208H post-fixing bath, one No. 24208J washing tank, one No. 24208D box of 5 developing cartridges, one pound carton of No. 24208F fixer, one No. 24208G eight-ounce conical graduate, one tube of No. 24208R paste for electrodes, and one No. 31274A occlusion goggle.....

\$999.00



No. 24208.

## REFERENCES

- General Experimental Psychology, A. G. Bills, pp. 535-574.  
 An Experimental Manual in Psychology, J. F. Dashiell, pp. 46-50, 58, 59, 145, 146, 148.  
 Fundamentals of Objective Psychology, J. F. Dashiell, pp. 205-228.  
 General Psychology, F. C. Dockeray, pp. 193-228.  
 Group Experiments in Elementary Psychology, A. Ford, pp. 227-229.  
 Great Experiments in Psychology, H. E. Garrett, pp. 221-247.  
 Laboratory Studies in Psychology, J. P. Guilford, pp. 149-155, 239-241.  
 Instructor's Guide, J. P. Guilford, p. 25.  
 An Elementary Course in Psychology, H. S. Langfeld and F. H. Allport, pp. 112-116.  
 Lying and Its Detection, J. A. Larson.  
 The Nature of Human Conflicts, A. R. Luria.  
 General Psychology, G. Murphy, pp. 65-107.  
 Psychology of Feeling and Emotion, C. A. Ruckmick, pp. 287-289.  
 The Measurement of Emotions, W. W. Smith.  
 A Psychological Laboratory Manual, W. L. Valentine, pp. 53-55, 79-88.  
 The Measurement of Emotional Reactions, D. Wechsler, "Archives of Psychology," No. 76.  
 The Science of Psychology, R. H. Wheeler, pp. 157-238.  
 Principles of Judicial Proof, J. H. Wigmore.  
 American Journal of Physiology, Vol. 3, No. 1, Feb. 1935, pp. 55-63.  
 American Journal of Psychiatry, Vol. 13, No. 2, Sept. 1933, pp. 285-298.  
 Archives of Neurology and Psychiatry, Vol. 32, Aug. 1934, pp. 273-299.  
 Esquire, April, 1935.  
 Forum and Century, Jan. 1935, pp. 15-18.  
 Journal of Experimental Psychology, Vol. 5, No. 5, Oct. 1922, pp. 323-328.  
 Journal of Experimental Psychology, Vol. 6, No. 6, Dec. 1923, pp. 387-454.  
 Journal of Experimental Psychology, Vol. 17, No. 5, Oct. 1934, pp. 739-748.

Journal of Experimental Psychology, Vol. 17, No. 6, Dec. 1934, pp. 847-861, 862-877.  
 Journal of Experimental Psychology, Vol. 18, No. 5, Oct. 1935, pp. 505-529.  
 Journal of Experimental Psychology, Vol. 20, No. 3, March 1937, pp. 262-278.  
 Journal of General Psychology, Vol. 4, Dec. 1930, pp. 418-420.  
 Journal of General Psychology, Vol. 7, No. 1, July 1932, pp. 215-219.  
 Journal of General Psychology, 1934, No. 11, pp. 445-453.  
 Literary Digest, June 1935.  
 Oregon Law Review, Vol. 8, No. 2, Feb. 1929, pp. 158-166.  
 Police 13-13, Jan. 1934, pp. 5, 6, 13. April 1935, page 19.  
 Psychological Bulletin, Vol. 33, No. 2, Feb. 1936, pp. 73-94.  
 Psychological Review, Vol. 42, No. 6, Nov. 1935, pp. 566-578.  
 Scientific Monthly, Jan. 1934, pp. 81-87.  
 The Insurance Index, June 1935, pp. 8, 9, 68, 69.  
 Time, Sept. 16, 1935, pp. 23, 24, 26.

**ITEMIZED LIST OF ACCESSORIES**

Number		Price
57113.	Pneumograph, Gutzmann and Scripture.....	\$ 6.00
56231A.	Inflatable Arm Bandage.....	6.67
24217.	Simple Electrodes, Darrow (2).....	10.00
19220.	Voice Keys, Boder's (2).....	25.00
19534.	Tremographs (2).....	75.00
24208B.	Bromide Paper, Eastman, P.M.C., No. 1, N.W.G.....	4.85
24208D.	Elon Quional (5).....	.30
24208F.	Acid Fixer, Eastman (1 pound).....	.30
24208H.	Post-fixing Bath.....	.50
24208J.	Washing Tank.....	.50
24208G.	Graduate, conical, 8 oz.....	1.00
24208E.	Lamp, 32 c.p., 6-8 volt.....	1.40
24208I.	Bottle, reduction, for respiration.....	1.25
24208R.	Electrode Paste.....	.75
31274A.	Goggle, blind-fold.....	.30

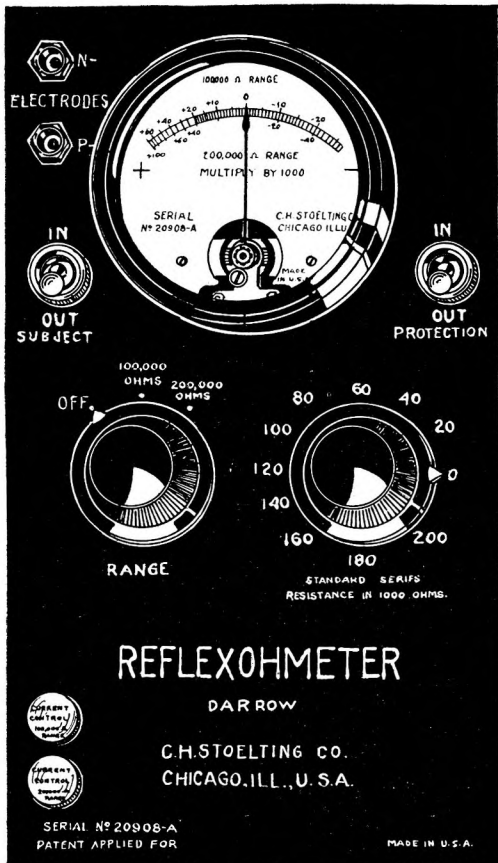

No. 24209A.

**N.B.** New supplementary equipment giving an additional record of continuous systolic blood pressure can be supplied with the photopolygraph on special order. The description of this apparatus by Dr. Darrow is expected to appear in the Archives of Neurology and Psychiatry for 1937.

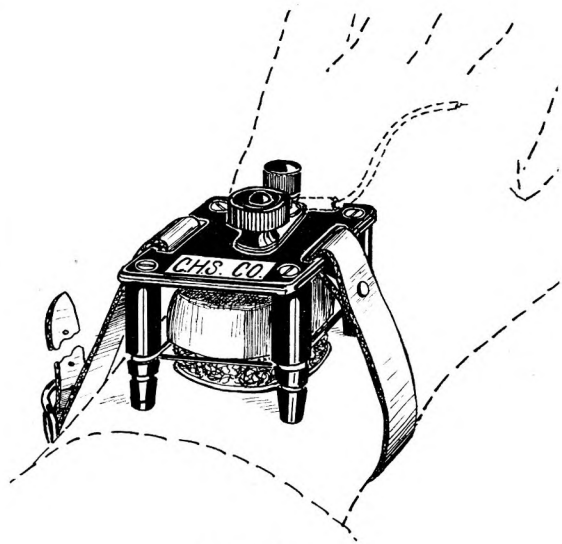

No. 24217A.



Number		Price
24209A.	<b>Reflexohmeter</b> , Darrow's. The need for an apparatus which would indicate the galvanic reactions to actual life situations, outside the laboratory, led to the construction of this instrument. It offers a pocket-size Behavior Research Resistance Box, plus a highly stable and moderately sensitive galvanometer (about .3 to .6 millimeter deflection per 1000 ohms change) for observing resistance levels and galvanic reactions. This instrument may be carried in the coat pocket, or open in the hand, or resting on the lap, the wires being run up the coat sleeve from electrodes on one hand. The subject may observe his own reactions or an observer may accompany the subject, recording resistance levels, reactions, and the nature of the stimulating situations. The illustration of the instrument on page 29 is largely self-explanatory. The Behavior Research Resistance Box circuit, with a recording range of 200,000 ohms is here used with a small microammeter, calibrated to read in 1000 ohm steps. An adjustable standard series resistance in 20,000 ohm steps permits maintaining sufficient resistance in the subject's arm of the bridge to keep the galvanometer within the dial range. A battery of three vest-pocket flash light cells give a uniform current of .0409 milliamperes through the subject's arm of the bridge at balance. As in the other form of the Behavior Research Resistance Box, used in No. 24208, the subject's resistance at any time equals the 100,000 or 200,000 ohms recording range (balance), minus the resistance in series with the subject, plus or minus (as the case may be) the deflection in ohms indicated by the galvanometer pointer on the scale. The wide applicability of this stable pocket size galvanometer equipment is shown by a preliminary study of galvanic reactions while automobile driving. The powerful effect of any situation requiring the mobilization of the driver's energies, such as the sudden slowing of another car in front, the attempt to pass another car on the road, the sudden appearance of a pedestrian in the road, or the sound of a policeman's whistle is clearly demonstrated. A study of the resistance levels of the galvanometer reactions (larger than 1000 ohms) during the actual activities and perturbations of daily life, rather than within the limits of artificial laboratory situations is made possible by this instrument. A pair of No. 24217 simple electrodes is supplied with each instrument. (186A:361; J.o.G.P., 1932, 6:471-473; J.o.G.P., 1934, 10:238, 239; S.B.R.F. and I.J.R., C., Series B, No. 193).....	\$134.45
24213.	<b>Electrodes</b> , Lauer's Improved model. This model has all the advantages of the original one, and many of the disadvantages have been eliminated. (J.o.E.P., Vol. XI, No. 3, June, 1928:248-251; A.J.o.P., Vol. XLII, No. 2, April, 1930:298-300).....	16.70
24214.	<b>Electrodes, Nonpolarizing</b> , Ruckmick and Patterson. Designed for finger contacts in connection with the psychogalvanograph and psychogalvanoscope. The electrode consists of a wooden container carrying two identical Pyrex glass tubes terminating at the bottom in two J-shaped capillary tubes, into which are fused platinum wire connections. The container may be readily clamped to the edge of a table or a chair with a desk-arm. (A.J.o.P. Jan. 1929: 118a-121) .....	15.00
24215.	<b>Electrodes</b> , Ruckmick's. Designed for studying the psychogalvanic reflex with the psychogalvanoscope. This hand electrode consists of a pliable leather bandage, furnished with two straps, on the inside of which is stitched a pair of very thin flexible copper electrodes with a section of rubber sponge between the leather strap carrying the electrodes and the bandage proper. When the bandage is strapped to the hand, the electrodes rest comfortably on the palm and the two straps may be fastened tightly enough to insure full contact. (A.J.o.P. Jan. 1930: 106, 107).....	7.50
24216.	<b>Electrodes</b> , Nonpolarizing, Phares'. A modification of the No. 24215 Ruckmick and Patterson nonpolarizing electrode. (J.o. Ex. P., Vol. XVII, No. 1, Feb. 1934: 120-121).....	18.00
24217.	<b>Electrodes</b> , Universal. Darrow's. Nonpolarizing electrodes consisting of two zinc bottom rubber cells, mounted on sponge rubber, with straps for attaching to hand or arm.....	10.00
24217A.	<b>Electrodes, Table-top</b> , Darrow's. Relatively nonpolarizable constant area electrodes, designed primarily for use with the No. 24208 Behavior Research Photopolygraph. Simultaneous records of resistance and perspiration in corresponding skin areas frequently give instances when, after increased sweating and a drop in resistance, the perspiration later decreased, but resistance did not show a corresponding rise. This suggested an irreversible physiological change under the electrodes. Examination of the skin showed pressure marks, and sometimes reddening of the skin. This electrode was devised to overcome the difficulty. The rubber knob and zinc disk in this electrode are supported on four legs resting on the skin, some distance from the area of contact. A light contact is made through a kaolin-zinc sulphate paste, impregnated rubber sponge with a moist filter paper disk of proper dimensions adhering to the skin. The disk is moistened in dilute physiological zinc sulphate and glycerin. This electrode gives reversible resistance changes more nearly corresponding to those manifested by perspiration than any other electrodes tried. They have a higher resistance, and this must be taken into consideration in making calculations. The electrodes may be used as follows: (1) As a zinc kaolin-zinc-sulphate electrode of the general type recommended by Richter (Brain 1927, 50, 216-220)—a smooth paste of kaolin ("washed and ignited" kaolin or "plain" kaolin will answer) in concentrated zinc sulphate is used to fill the cup of the electrode. (2) As a zinc kaolin-zinc-sulphate physiological salt solution electrode of the type used by Darrow ("Journal of General Psychology," 1932, 6, 473-476). A layer of absorbent cotton saturated with physiological salt solution is interposed between the concentrated zinc sulphate paste and the skin. (3) As a zinc, manganese dioxide, physiological salt electrode of the type recommended by Davis ("Ability in Social and Racial Classes," Century, 1932). A layer of MnO <sub>2</sub> is placed next the zinc, and absorbent cotton with physiological salt on top of this, next the skin. A disc of blotter or filter paper may be placed between the MnO <sub>2</sub> and the cotton if desired. Both electrodes, rather than only the negative electrode, should be prepared in this way to insure equi-potentiality. (4) As a zinc, physiological salt electrode. Absorbent cotton soaked in physiological salt is placed in the electrode. (5) Same as above with dilute physiological solution of zinc sulphate in place of normal salt solution.....	25.00

Number		Price
24505.	<b>"Psychodiagnostik" Test, Rorschach's.</b> An unusually effective test for probing both the superficial and innermost depths of the mind. It is composed of a series of black and colored ink blots, something on the order of the Whipple and similar imagination tests. The test includes ten large test cards and a mimeographed manual made up of the first article on the test printed in the English language. (Arb. z. Angew. Psychiatrie, Bd. II, Rorschach: Psychodiagnostik; A.J.o.Ps., 10, 1930:19-22; A.J.o.O., 1, 1930:81-88, No. 1, 1931:501-511; A.J.o.P., Vol. XLV, 3, July 1933:433-443; A.r.o.P., May, 1932, 36-84; B.J.o.P., Vol. XXV, Part 2, Oct. 1934; 170-185; J.o.N.a.M.D., Nos. 3-4, 1924:225-248, 359-379; "Manic-Depressive Psychosis": 167-181; "Psychodiagnostik," Rorschach, II, Ed. 1932; P.B., Jan. 1935; P.R. Vol. XL, 2, Mar. 1933; 12A:84.) Mounted .....	\$ 6.10
24505B.	<b>Manual, Rorschach's.</b> An English translation of Dr. Rorschach's original paper, which appeared in "The Journal of Nervous and Mental Diseases," Vol. 60, Oct. 1924, Nos. 3 and 4. . . <b>N.B.</b> We now have in stock the third edition of the book "Psychodiagnostik," printed in German, which gives a detailed account of the test and its use. The price is \$3.60.	2.50
24506B.	<b>Personal Data Sheet.</b> Papurt's revision of the original No. 24506 Woodworth Psychoneurotic Inventory. This is an attempt to eliminate what the author believes to be the five major faults of the original. These faults are: complex terminology, length of the questionnaire, irrelevancy of subject matter, applicability of the original questionnaire only to the male sex, and duplication of content and symptomological diagnosis. The Papurt revision contains only seventy-five questions, formulated in very simple English, and applicable to either sex. Duplication of content and questions having little or no bearing upon emotional instability have been eliminated. (J.o.A.a.S.P. Vol. XXV, No. 3, Oct.-Dec. 1930:335-352.) Per 25 .....	2.25
	Per 100 .....	6.75
24506C.	<b>Manual, Papurt's for the No. 24506B.</b> .....	.75
24508.	<b>Personal Data Sheet, Woodworth and Cady.</b> A modification of the original Woodworth Psychoneurotic Questionnaire, modified by Dr. Vernon M. Cady for use in his study of juvenile incorrigibility. (24A; J.o.E.P. Sept. 1930.) Per 25 .....	2.85
	Per 100 .....	8.50
24508A.	<b>Personal Data Sheet, Woodworth and Cady.</b> Modified by Dr. F. C. Richmond to meet the requirements of the Wisconsin Psychiatric Field Service. It is used for all individuals 10-16 years inclusive turned over to the state institutions. (Med.-Leg. Jour. May-June 1931:74-78.) Per 25 .....	2.85
	Per 100 .....	8.50

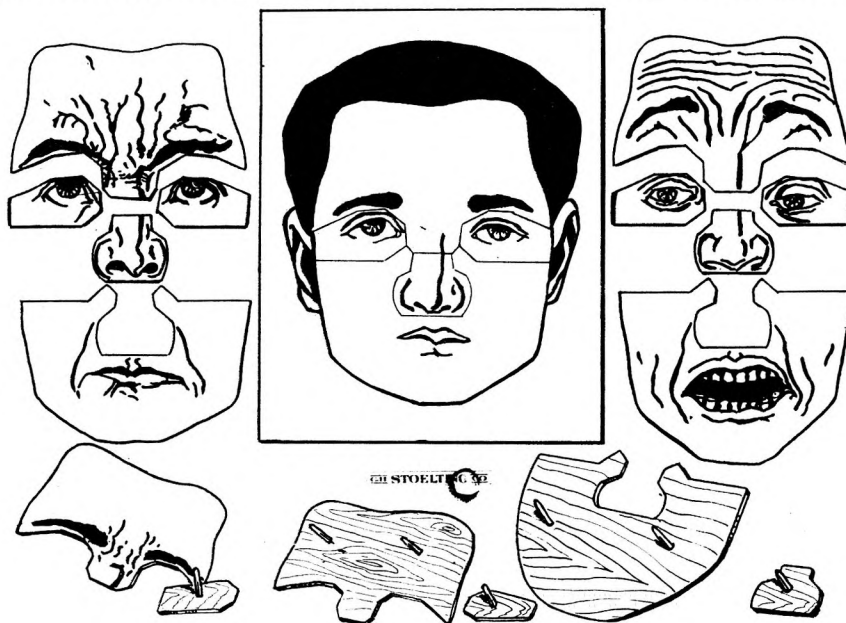

No. 24510.

24510. **Facial Model, Full Face, Articulated, Guilford's.** Supplementing the No. 24509 Boring and Titchener Articulated facial profile. It is mounted in much the same way and provides a large number of expressions which in the nature of things cannot be demonstrated by a profile model. The basic section, consisting of the scalp and ears, is mounted on a base board approximately 18x24 in. The complete face itself is 17 in. in height and 11 in. wide at the ears. The different sections are supplied with wooden pins for attaching to the base board, similar to the Boring and Titchener articulated facial profile. The face is evenly divided horizontally into two parts: the upper section includes the forehead, eyes, brows, and upper part of the nose; the lower section, the chin, mouth and cheeks. Each eye and the lower part of the nose are mounted separately. The expressions were taken from the Rudolph sketches and Ruckmick's photographs. There are 7 brows, 9 pairs of eyes, 4 noses, and 13 mouths, making possible almost 3000 combinations. (A.J.o.P. July 1930:436-439; 78:S24; 186A:248, 249) .....

80.00

Number		Price
24515.	<b>Rating Scale</b> , Uhrbrock's. For graduate students. This is an extensive rating scale designed for students desiring to undertake graduate work. It defines a combination of 25 traits which are thought to be related to vocational success. Per 10.....	\$ 5.00
	Per 25 .....	10.00
24516A.	<b>Personal Questionnaire</b> , Jones'. This is the 1931 revision of the questionnaire prepared by Dr. E. S. Jones of the University of Buffalo. For additional details refer to page 119 of the 1930 edition of our general catalog. Per 25.....	5.60
	Per 100 .....	16.80
46305.	<b>Manual</b> , Jones'. For No. 24516A.....	.50
24521.	<b>Developmental Age Test</b> , Furfey's. This test is very helpful in diagnosing cases of maladjustment among boys not reached by other tests. The concept of developmental age introduces quantitative methods into a field in which hitherto research has been on a purely descriptive level. Children show surprising differences of maturity in their reactions apart from their differences in intelligence and physical development, and since developmental age is connected with the growth of the whole personality rather than with a single aspect of it, as in the case of mental, educational, or physiological age, this new concept ought to be of the greatest importance to the clinician, the student of delinquency, the recreational leader and others who deal with the boy outside of his school hours. (A.J.o.Ps. 8, 1, July 1928:149-157; Ment. Hyg. 14, 1, Jan. 1930:129-136; Cath. Educ. Res. Bul. 2, 10; P.B. Mar. 1928, 26:159, 160; S.a.S. Feb. 6, 1926, 23:183, 184; "The Growing Boy; Case Studies of Developmental Age," Macmillan, 1930; Rep. of Char. Educ. Res. Conf. 1928:67-82; Child Development June 1930). Per 25 .....	2.75
	Per 100 .....	7.50
24521A.	<b>Manual</b> , Furfey's. For No. 24521 Developmental Age Test.....	.25
24524.	<b>Personal History Record</b> , Thompson's. This test is, first, a rather sensitive index of emotional apathy or stability, and secondly, the individual study of the particular items has been found very helpful in unravelling personality difficulties of students. The author states that in a recent study the record revealed that those students who are less stable emotionally are superior in scholarship, that the men are on the average more stable than women, and that both men and women are more emotional in their attitudes in the junior than in the freshman year. (J.o.S.P.). Per 25.....	2.50
	Per 100 .....	7.50
24524A.	<b>Manual</b> , Thompson's. For No. 24524 Personal History Record.....	.25
24529.	<b>Psychotic Questionnaire</b> , Richmond's. Devised by the Director of the Wisconsin Psychiatric Field Service, for use in the examination of inmates of correctional institutions who are suspected of having mental disease. It can be used in the examination of any individual suspected of having mental disease or being examined to ascertain whether or not he or she is certifiable as insane. It may also be applied to inmates of mental hospitals for diagnostic purposes. The questionnaire should be used in conjunction with the Nos. 24506 and 24506A Woodworth and Richmond revision of the Personal Data Sheet. Per 25.....	2.25
	Per 100 .....	6.75
24529A.	<b>Directions</b> , Richmond's. For No. 24529 Psychotic Questionnaire.....	.15
24532.	<b>Introversion-Extroversion Test</b> , Marston's. Devised at the State University of Iowa for the measurement of introversion and extroversion traits of young children between two and six years of age, by means of ratings. (62A:IIc3; 125). Per 25.....	1.00
	Per 100 .....	3.00
24534.	<b>Tact Test</b> , Scheidemann's. A very comprehensive test designed to test an individual's tact. This test also includes a test of the ability to interpret facial expressions. (In preparation.)	
46647.	<b>Manual</b> , Scheidemann's. For No. 24534 Tact Test. (In preparation.)	
24535.	<b>Self-Appraisal Schedule</b> , Wang's. The purpose of the Self-Appraisal Schedule is to provide a schedule for obtaining a fairly reliable measure of the trait persistence, using the term as it is ordinarily understood. In order that the subject may not know that the test concerns persistence and withholds the truth in answering, the schedule is given the noncommittal title of the "Self-Appraisal Schedule." The items in the schedule covering 112 questions answered by yes or no have been collected and developed from a large number of sources, chiefly from individual descriptions of persistent behavior but also from personal data schedules and questionnaires. (J.o.S.P., 1932:79-90). Per 25 .....	2.50
	Per 100 .....	7.50
24535A.	<b>Manual</b> , Wang's. For No. 24535 Self-Appraisal Schedule.....	.35
24536.	<b>Honesty Test</b> , Tuttle's. A specially devised spelling test administered by a method that induces the individual to think he can make corrections without detection. (R.E. 1931, 26:742-747; J.o.E.S., Dec. 1931:232-239; C.E.b.S.a.C., Abingdon Press, 1931; P.f.C.E., Univ. of Ore. Co-operative Store, Eugene, Ore.) Per 25.....	4.00
	Per 100 .....	12.00
24536A.	<b>Directions</b> , Tuttle's. For administering and evaluating the No. 24536 Honesty Test.....	.50
24538.	<b>Personality Index and Success Guide</b> , Davis'. It is claimed that this index covers the absolutely fundamental factors found by exhaustive analyses to be inseparably associated with success, mediocrity, or failure. Derived from a combination of questionnaires and personal scientific analyses of 900 persons: 300 very successful, 300 of ordinary accomplishment, and 300 complete failures. Per 25.....	2.50
	Per 100 .....	7.50
24540.	<b>Annoyance Test</b> , Cason's. This questionnaire covers those concrete stimuli, situations, and responses which can be adequately described as common everyday annoyances, aversions, and irritations. There are 217 items, to which the individual may refer as "extremely annoying," "moderately annoying," "slightly annoying," "not annoying," or "have not been in the situation," by marking the item "3," "2," "1," "0," or "X" respectively. (J.o.A.a.S.P., 1930, 25:224-236; 24.) Per 25.....	2.00
	Per 100 .....	6.00

Number		Price
24543.	<b>Personal Traits Rating Scales, Minnesota, Heibredner's.</b> Part I of these scales consists of traits which, by their presence or absence are usually considered indicative of the inferiority attitude. Part II consists of traits usually considered characteristic of introversion; their opposites therefore may be considered indicative of extroversion. Both scales have shown rather definite positive relationships with measures of temperament and emotionality, such as the Woodworth questionnaire and the Allport A-S Reaction Study; i.e., correlations suggest that introversion and the inferiority attitude according to the scales are associated with emotional instability and lack of aggressiveness as measured by the tests mentioned. The scores are to be taken as suggestive rather than conclusive—as indications of trends rather than as precise determinations of definite conditions. It is important that this point be recognized. The scales have shown no significant relationships with abilities of any kind, either with general abilities such as those measured by college ability tests and college marks, or with special abilities such as musical ability, literary appreciation, art appreciation, or mechanical ability. (J.o.A.S.P., Oct.-Dec. 1927:243-258; J.o.A.S.P., Apr.-June 1927:52-61; J.o.S.P., Aug. 1931:374-396; 62A:11c3). Per 25.....	\$ 2.50
	Per 100 .....	7.50
24543A.	<b>Stencil, Heibredner's.</b> For the No. 24543 Personal Traits Rating Scales.....	.75
24543B.	<b>Manual, Heibredner's.</b> For the No. 24543 Personal Traits Rating Scales.....	.45
24545.	<b>Introversion-Extroversion Test, Marston's.</b> For children. A set of two games, one consisting of a carrying case, cylindrical boxes, a pan, and a number of celluloid ducks; the other of a set of toys comprising a swing, merry-go-round, and teeter-tauter. (123:49-77).....	19.00
24548.	<b>Social Adequacy Measuring Scale, McCormick's.</b> This scale was worked out by Dr. Mary J. McCormick as part of her doctorate thesis at the Catholic University of America, under the supervision of Dr. Paul Hanly Furfey. By means of this scale it is possible to measure the social adequacy of families. A measure of this kind is of importance in a large number of investigations in the fields of psychology and applied sociology. (A.J.o.S. 36, 1931:782-809; 126). Per 25 .....	2.00
	Per 100 .....	6.00
24550.	<b>Social Situation Pictures Test, Schwartz's.</b> A series of eight pictures, 9x12 in., for use with boys in the psychiatric interview. These situation pictures were developed in order to gain a quicker rapport, obtain the attitudes, and to attempt to gain information on the intra-psychic activities of the delinquent. The child is allowed three minutes to describe the picture from an objective intellectual standpoint. He is then told that every picture has a meaning and is asked to describe the feelings and attitudes of the boy in the picture, and finally, what he would do under similar circumstances. The child's responses have been divided into four categories: (1) the autistic reveries and fantasies; (2) the responses to bodily pleasures, or somatic reaction; (3) adjustive thinking, in which the boy has to make a decision; and (4) instinctive emotional responses, such as fear of death. These four categories overlap and cannot be separated, but serve to classify the child's responses. There are two pictures for each of these categories. (Prog. of 8th Annual Meeting of Amer. Orthopsychiatric Assn., Hotel Penna., N.Y.C., Feb. 20-21, 1931; A.J.o.O., 1932, 2:124-133). Per set.....	10.00
24550A.	<b>Manual, Schwartz's.</b> For use with the No. 24550 Social Situation Pictures Test in the psychiatric interview .....	.50
24551.	<b>Social Situation Pictures Test, Schwartz's.</b> This series of six pictures, 9x12 in., was developed for use with girls. It constitutes a companion series for the No. 24550 developed a few years ago for use with boys. These pictures, like the series for boys, serve to obtain a quicker rapport, the attitudes and general information on the intra-psychic activities of the delinquent. The six pictures include the following: (1) Rivalry; (2) Overprotection; (3) Fear—Corporal Punishment; (4) Washing Dishes; (5) Fantasy of Father and Sweetheart; and (6) Physical Appearance. Per set .....	2.50
24551A.	<b>Manual, Schwartz's.</b> For No. 24551 Social Situation Pictures Test for girls.....	.15
24553.	<b>"Personality Chart," Sweet's.</b> Designed to provide the complete and organized psychoanalysis of the human personality. The corrective measures (reflex) to be employed are charted under the "Library of Complexes" for both normal and abnormal subjects. This "chart" embodies, in 26 pages, the study and experience of a professional psychoanalyst with an experience extending over almost a quarter of a century.....	1.15

### MISCELLANEOUS ACCESSORIES

25305.	<b>Pistol, Target, .32 calibre.</b> (50:X19). Purchase locally.	
25306.	<b>Cartridges, .32 blank, rim fire.</b> (50:X19). Purchase locally.	
25423.	<b>Disk-Spinner, Ford's.</b> Modified for individual use in mixing color disks. Superior to the color top for rotating disks. (50:X21).....	.40
25423A.	<b>Color Disks.</b> For the No. 25423 Ford Disk-Spinner.....	.20
25438.	<b>Daylight Lamp (110-volt).</b> Mounted on a special standard. Used for providing standard illumination in administering color perception tests, etc.....	47.50
25460.	<b>Opaque Projector.</b> A small piece of apparatus devised for illuminating and projecting the dial of the Dunlap Chronoscope on a screen so that it can be readily seen by an audience. (50:X17) .....	10.60
	(Above projector with ½ plate objective, \$25.00 extra)	
25462.	<b>Hooded Screen.</b> For exposing films. This screen is collapsible and so readily portable. The screen surface is approximately 3x5 ft., whereas the front of the hood is 4x6 ft. The sides are made of beaver-board with the inside painted white. (50:X27).....	30.00
25463.	<b>Photographic Shutter.</b> With fittings for converting lantern into a tachistoscope. (50:X30)....	27.80
25470B.	<b>Projector, Film.</b> The type of projection lantern that has stood the test of years in commercial service. It is comparatively inexpensive for a high-grade instrument of this type and besides being substantially constructed, possesses the adaptability required in the psychological classroom. It is reasonably safe for operation even in the hands of the tyro. Illumination is supplied by a 500-watt incandescent lamp, and a single cord to the 110-volt A.C. or D.C. suffices for both lamp and motor. Resistance is of the "fixed" type, built in, and the cooling and ventilating systems are such that the projector can be run for a long period of time without becoming unduly heated.	

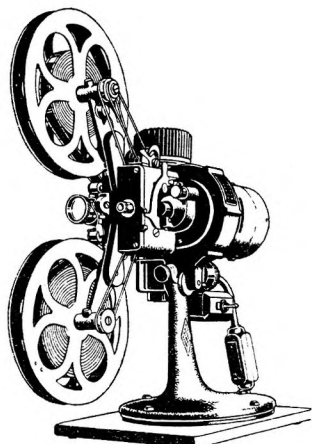

No. 25470B.

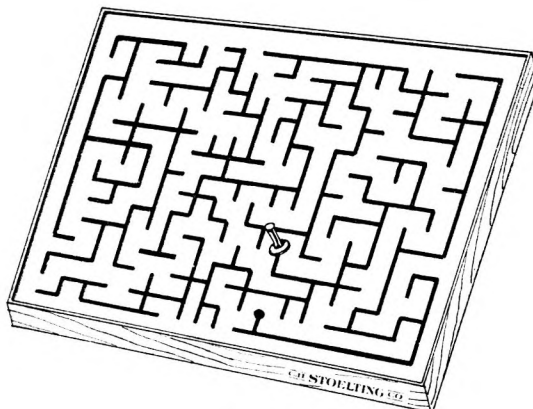

No. 27138.

Number

Price

The projector is mounted on a heavy base which permits rapid and accurate elevation or depression of the lantern proper for centering the picture vertically on the screen. The lens (one of the popular Cooke objectives of 2 in. focus) gives a brilliant and undistorted image. A slight turn of the lens barrel focuses the image sharply on the screen.

Screen Distances and Picture Widths:

Distance from screen:	8'	10'	12'	16'	20'	25'
Width of Picture:	1'6"	1'10"	2'3"	3'	3'9"	4'8"
Distance from screen:	32'	36'	40'	45'	50'	64'
Width of Picture:	6'	6'9"	7'5"	8'5"	9'4"	11'11"
Distance from screen:	75'	100'	125'	150'		
Width of Picture:	14'	18'9"	23'5"	28'1"		

The condenser is designed to transmit the maximum illumination over the entire area of the film frame. The projector possesses both forward and reverse movements. It is equipped with both electrical and manual rewinding. A speed regulator provides for reducing or increasing the speed of the frames from the customary rate of 16 per second. Single frames may be shown for reasonable periods without endangering the film. Threading is rapid and simple. It takes but a moment, as the double-toothed shuttle mechanism is provided with large sprockets and the loop of film used in threading is visible during the entire operation. Capacity: 400 ft. of 16 mm. film; weight, approximately 12 lbs. Carrying case (8x12½x16 in.) included

\$140.00

**N.B.** The lens and filter assembly and the auxiliary condenser for showing "Kodacolor" pictures can be added at any time without any change whatever in the machine itself.

- 25512. **Balanced Relay**, Metfessel's. Used on the No. 23320 psychodimeter, and similar equipment, requiring a carefully made balanced relay. .... 11.25
- 25516. **Relay, "Pony."** A simple, inexpensive relay. .... 5.00
- 25576. **Geissler Tube**, 6 in. (A.J.o.P. 12:590-594). .... .75
- 25594. **Rectifier**, Dry Metallic, 2 amperes, 24 volts. For converting the 110-volt A.C. into direct current 39.50
- 25595. **Rectifier**, Dry Metallic, 2 amperes, 6 volts. For converting the 110-volt A.C. into direct current 11.50
- 25597. **Rotary Converter**. For converting the 115-volt D.C. into 110-volt A.C. For operating the No. 14618 Phono-projectoscope and other alternating current equipment on the direct current. .... 46.00
- 25620. **Clamp, Table**. For No. 12851 Head Rest. (241:X24). .... 4.00
- 25633. **Clamp, Right Angle**, 19 mm. "V" opening and 13 mm. circular opening. .... 1.00
- 25761M. **"Y"-Tube**, Metal, ¼ in. .... .75
- 25817. **Pencils, Grease**. Set of 3: red, blue, and yellow. Very useful for making temporary marks upon the skin. The marks may be readily removed with ether, xylol, or something similar. These pencil marks do not disfigure the skin like ink. (55:19-25; 57:26-31; 241:X25). .... .75

**ATTENTION—PERCEPTION—  
COMPREHENSION—APPREHENSION**

- 27138. **Slot Maze C**, Young's (H. H.) A slot maze test difficult enough for adolescent and adult ability levels. The slots are cut in a three-ply board which is securely mounted on a wooden base. Many simple and complicated blind alleys lead off both to the right and left from the continuous slot which runs from the starting point to the goal. The stylus (called a "submarine") has a small knob on the bottom end. This is submerged beneath the slotted board at the starting point. The handle of the stylus extends up through the slot far enough to be grasped and guided by the hand. Because of the small submerged knob, the person being tested cannot remove the stylus from the slot, but he may, if he chooses, remove his hand and leave the stylus at any point while he surveys the maze. This test has not been standardized but standards are being worked out and will be available in the near future. (187A:T132). ... 35.00

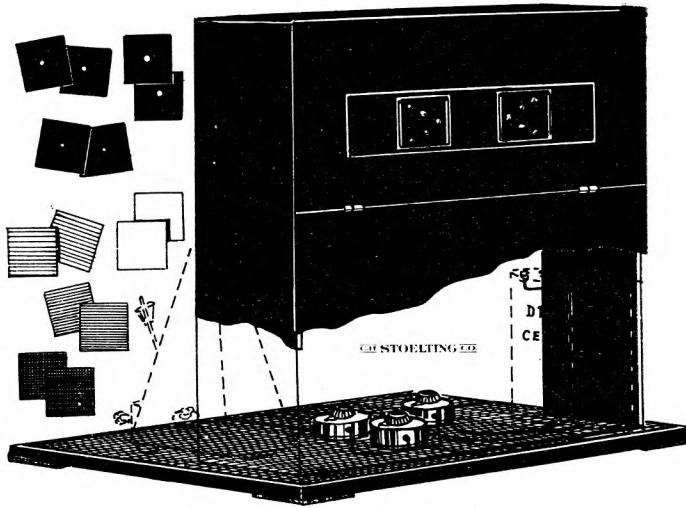

No. 27143.



No. 27145.

Number		Price
27143.	<b>Phi-Phenomena Apparatus</b> , Seward's (improved form). Unlike the No. 27144 Carmichael Apparent Movement Apparatus, the images in this apparatus, when set at a certain distance, remain stationary while the illumination is changed from one slot to the other, by means of a mercury metronome (not included in the price), thus making it possible to change the speed of the apparent movement and secure quantitative results. The distances between the figures are adjustable by means of a very effective device at the rear of the case. In addition to this device for controlling the separation of the images, adjustable rheostats are provided for controlling the intensity of the illumination of the lamps, both individually and collectively. (A.J.o.P., Apr. 1932, Vol. XLIV:348-349; 12B:153-155, 159-162).....	\$ 50.00
27145.	<b>"Yogi" Puzzle</b> . This inexpensive puzzle provides an excellent demonstration of the Phi-Phenomena. It is approximately 2 1/4 in. in diameter, and about 1 in. in height. Inside of the glass covered metal case is the picture of a fakir and a headless subject. Attached to the hands of the fakir, in the center of the puzzle, is a two-handed sword which apparently passes through the neck of the subject. The neck is represented by a metal peg carrying the head, and passes through the glass cover to the bottom of the case. The circular movement of the sword can be made to take place either clockwise or anti-clockwise, and is so rapid that it gives the observer the impression of the sword having actually passed through the metal peg representing the neck of the subject. One of the best illustrations of apparent movement. (A.J.o.P., Vol. XLVIII, No. 3, July, 1936:509, 510; J.o.Ex.P., Vol. XIX, No. 4, Aug. 1936:524)....	.40
27146.	<b>Problem Box</b> , Hayes' (J.). A problem or puzzle box something on the order of Nos. 27141, 27147, and 31266, requiring six operations for opening. (37:38, 39).....	26.50
27157.	<b>Form Board</b> , Seguin and Goddard. With insets lighter in color than the base board and recesses the same color as the board. Made especially for use with Dr. Grace Arthur's Performance Scale. (5A:51).....	12.50

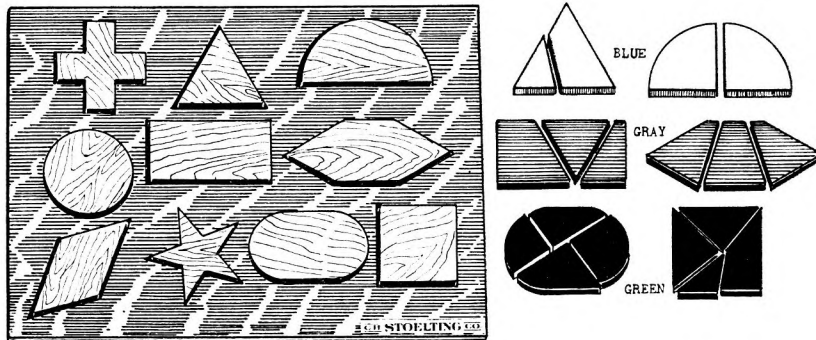

No. 27162A.

27162A. **Form Board**, Papurt's. This test has been devised by Dr. M. J. Papurt, Psychologist at The Institution for Male Defective Delinquents at Napanoch, New York. The purpose of this test is to present a series of form boards standardized upon the adult inmates of the various New York Correctional Institutions. The inserts range in difficulty from the simple type such as the No. 27156 Goddard Revision of the Seguin Form Board to the highly complex multiple inserts. The base board used is the same as that in No. 27156.

Number		Price
	There are four sets of inserts; those of the No. 27156 and one set each of 2, 3 and 4 sections, graded in difficulty. The inserts fit into recesses ranging from $3\frac{1}{4}$ to $6\frac{1}{2}$ in., and project above the base-board. The test is especially recommended for studying the non-language abilities of both children and adults. By use of this one series of form boards, an insight may be had as to the performance ability, manipulative ability, sensory motor co-ordination, and the reasoning and planning ability of the subject. The sets of inserts are painted in varying colors—brown, blue, gray and green—so that they can be readily distinguished. This series attempts to answer the objections raised against many of the other form boards, namely that they are suitable only for children and not complex enough for adults.....	\$ 40.00
27164A.	<b>Form Board, Kent's.</b> A modification of the No. 27164. Makes use of only 2 of the insets of the No. 27164, and these are larger than the corresponding blocks in the original form board..	7.00
27179D.	<b>Eight-task Series, Danvers,</b> for the No. 27179 Dearborn form board. A series of 9 photographic reproductions comprising a demonstration card and 8 cards providing problems to be solved by 3, 4, 5, 6, 7, 8 and 9 moves. These problems were devised by Dr. Grace H. Kent for enhancing the usefulness of the No. 27179 Dearborn form board 3. The board was originally devised for presenting four problems of increasing difficulty, while at the same time minimizing the possibility of chance placements. Set of nine $3\frac{1}{2}$ x5 in. cards.....	1.80
27240.	<b>Instruction Box, Hayes' (J.).</b> This box provides a series of tasks which are to be complete within a time limit of three minutes. It is the type of test like that provided by the No. 27239 Instruction Box, designed to bring out the capacities which the subject may or may not have for following instructions. (37:31-35).....	10.00

### ASSOCIATION

30495.	<b>Guilt Stimuli, Metfessel's.</b> Two glass-topped boxes with covers. One box contains a model of a revolver and the other a model of a frog. The boxes are approximately 4x6 in. and of the required height. (128:62; 128A).....	6.90
30496.	<b>Stimulus Cards, Metfessel's.</b> A set of 50 cards for detective use of the Free Association Test. These cards are used with No. 30495 Guilt Stimuli. Ten of the 50 cards are used for preliminary work. (128:62; 128A).....	5.00

### LEARNING—HABIT FORMATION

31059.	<b>Spot Pattern Test, Pyle's.</b> A set of 5 seven-spot patterns for use with the No. 21233 Disk Tachistoscope in studying the learning of visual patterns. (176:X9).....	2.25
31065.	<b>Nonsense Syllables, Poffenberger's.</b> A form containing sets A and B. (155:X14). Per 100.....	1.50
31202.	<b>Mirror-Tracing Test, Lauterbach's.</b> An outline of a six pointed star made up of a series of small circles. It represents an improved technique in the mirror tracing experiment. Omissions are the only errors recognized and these are subtracted from 132, the total number of circles, to obtain the total number of points earned. Divide the total number of points earned by the time in minutes to obtain the final score. If the tracing is completed in less than one minute, divide the total number of points earned by the time in seconds and multiply the quotient by 60. The experiment has considerable merit for demonstrating trial and error learning. (J.o.Ex.P. June 1933:451-453; 209, III Ed:CIX). Per 100.....	1.50

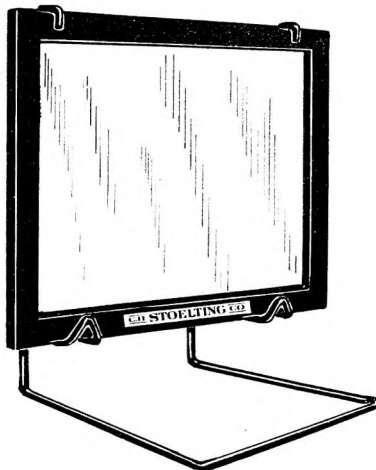

No. 31212A.

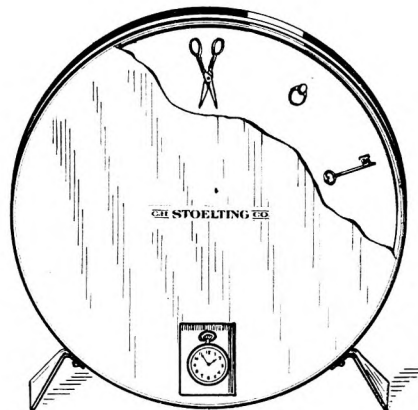

No. 32332.

31212A.	<b>Mirror-Tracing Apparatus, Metfessel's.</b> A simplified form for attachment to the writing arm of the lecture room chair. The price includes mirror, wire chair hand clamp and hand shield. (128:89; 128A).....	1.30
31219.	<b>Figures, Freeman's.</b> A series of 6 cards with a different figure on each. (59:X2).....	1.50
31236A.	<b>Puzzles, T-F-L, Metfessel's.</b> Three puzzles made of fibre. (128:123; 128A; 240:X23).....	1.70

Number		Price
31239C.	<b>Racket-Paddle</b> , Kline's. An instrument to be used for observing the learning processes involved in eye-hand co-ordination in performing a skillful operation. It is made from light 3-ply wood of a definite weight; its shape and size as to length and width is similar to a tennis racket. A light wood ball, of definite weight and diameter suspended at the end of a string 30 cm. in length, attached at the distal end of the racket-paddle, is to be caught in turn in each of the nine holes of the paddle, beginning with hole No. 1. The problem is one in acquiring motor skill. The learning is regarded as complete when the ball can be caught in each of the nine holes in turn as numbered, without making a single error. Several problems for laboratory exercises are possible: 1. Acquiring motor skill where both hand and eye are involved. 2. Effect of spaced and unspaced practice. 3. Cross transfer. 4. Effect of using one eye in practice and also the unpreferred hand, etc. (J.o.G.P., 1936).....	\$ 10.00
31245A.	<b>Sorting and Dealing Placard</b> , Valentine's. This is a sorting and dealing card 24 in. square made of heavy cardboard and divided into four sections by heavy perpendicular black lines joining the middle of the sides. Each section is marked with the symbol of one of the units. (241:X28)	2.50
31259.	<b>Rocker Puzzle</b> . A celluloid covered rocker with pockets at each end for the two enclosed steel balls. The problem consists in getting the two steel balls resting in the center of the rocker into the pockets at the ends. (50:X34).....	.25 2.00
31265A.	<b>Multiple Choice Apparatus</b> . Ohio State University modification of the Yerkes Multiple Choice Apparatus No. 31265. This is a miniature model approximately 16x10x16 in. and weighs about 8 lbs. (32D:421-424; 241:X33; A.J.o.P., July 1931:497-498).....	60.00
31274A.	<b>Blindfolds</b> . Goggles and a package of "Kleenex" tissue paper the same as used with the No. 31274 Miles High Relief Finger Maze (128:16; 128A).....	.30
31276.	<b>Demonstration Maze Board</b> , Michigan. This piece of apparatus consists of the maze proper and a signal light panel. The maze board is placed in an adjoining room where the subject cannot hear the sounds from the class. (This is very important, as the sounds from the class often tell the subject whether he is right or wrong in entering an alley.) A cable leads from the maze proper to the panel of small electric lights set into a picture of the maze before the class. A card with a hole in the center hangs in front of the maze board. The subject follows the alleys with a metal stylus through the hole in the card, which allows him to see just the width of one alleyway. As the metal stylus touches the bottom of the alleys, a circuit is closed and the proper globe on the panel is lighted to indicate the position of the subject. The floor of the grooves in the maze is laid in copper squares, each connected to a corresponding light on the panel board. Cubes of wood are fastened permanently to the floor in the positions represented by the white blocks in the illustration on page 154 of the manual. Movable cubes are then placed between the permanent cubes in such a manner as to form the maze pattern. The movable cubes are shown in black in the illustration. It is possible, therefore, to change the maze pattern quickly. The form of the maze pattern is represented on the panel board in chalk lines. The subject follows the pattern with a metal (brush) stylus placed in a hole cut in a fibre-board (or cardboard) shield which is laid on top of the maze. The subject can see only the width of one alley. (50:X26).....	295.00
31291.	<b>Columbia Obstruction Box</b> or Motivation Apparatus for white rats, Jenkins and Warden. This apparatus is constructed the same as the apparatus for monkeys, except in size. The dimensions of the compartments are 10x10x10 in., having 10 in. long passage with adjustable roof from 3 to 5 in. high. Doors are of celluloid instead of wire. A complete exposition of the technique and results of an extensive project will be found in "Studies in Animal Motivation." (241:X8) .....	305.50

### MEMORY—RECOGNITION

32002.	<b>Immediate Memory Test</b> , Metfessel and Hovey. A single-face 12 in. phonograph record, standardized in the psychological laboratory of the University of Southern California. Used to demonstrate the survival of immediate memory by a set of 60 questions concerning the story told by the record. After the record has been heard, the subjects check their answers in the appropriate columns of a record blank with which they were previously provided.....	2.75
44070.	<b>Record Blanks</b> , for No. 32002 Phonograph Record. Per 100.....	2.25
32138.	<b>Recognition Test</b> , Poffenberger's. This test consists of ten sets of 40 pictures each (400 in all) for studying memory by the recognition method. The pictures are carefully selected postal cards obtained by a careful selection of cards from every known source. A valuable recognition test which probably later on can not be duplicated for several times the present price. (165:X12)	17.00
32318.	<b>Reproduction Test</b> , Diamonds, Yerkes and Foster. (285:102, 103, 113, 114).....	.20
32320.	<b>Copying Test, Circle</b> , Stutsman's. (220).....	.20
32321.	<b>Copying Test, Cross</b> , Stutsman's. (220).....	.20
32322.	<b>Copying Test, Star</b> , Stutsman's. (220).....	.20
32332.	<b>Visual Memory Test</b> , Bayley's. Test III of the Bayley Performance Tests for three-, four-, and five-year old children. The apparatus is an exposure device for showing, one at a time, a number of articles attached to a revolving disk. The objects were selected carefully to fill two conditions: (1) they must be objects commonly experienced and seen in any home; (2) they must be the actual size ordinarily experienced by the child. The apparatus is very light and portable. (P.S.a.J.o.G.P. Sept. 1926:435-545).....	25.00

### SUGGESTION—HYPNOTISM—IMITATION

33206.	<b>Hypnotic Apparatus</b> , Hull's. This includes an electric phonograph motor with turn-table and adjustable speed control, an electric phonograph pick-up with tone-arm and volume-control, a dynamic loud-speaker, baffle-board, a seven-tube A.C. table-model radio set, an adding machine carriage provided with large rubber-tired casters, and a 10-in. aluminum phonograph disk. On one side of the disk is recorded, in the voice of the person conducting the experiment, four minutes of suggestions to postural movement. On the other side is recorded four minutes of hypnotic suggestions designed to be used in conjunction with the hypnotic head-piece and polished aluminum fixation-object (No. 33203). (A.J.o.P., July 1930:442-444).....	250.00
--------	----------------------------------------------------------------------------------------------------------------------------------------------------------------------------------------------------------------------------------------------------------------------------------------------------------------------------------------------------------------------------------------------------------------------------------------------------------------------------------------------------------------------------------------------------------------------------------------------------------------------------------------------------------------------------------------------------------------------------------------------------------------	--------



Number		Price
34054B.	<b>Pictorial Completion Test II</b> , Healy's. Modified for Great Britain and the colonies, by providing a block with the Union Jack instead of the Stars and Stripes.....	\$ 15.50
34054C.	<b>Pictorial Completion Test</b> , Woods' (Louise). Designed as a companion test to Healy's Pictorial Completion Test II, No. 34054. The scenes illustrate the successive events of a schoolgirl's day and, while similar in setup, the individual pictures present a new series of problems. The size and character of the boards, arrangement of pictures, and number and arrangement of insets correspond to Healy's test.....	15.50

**DISCRIMINATION—REASONING—JUDGMENT**

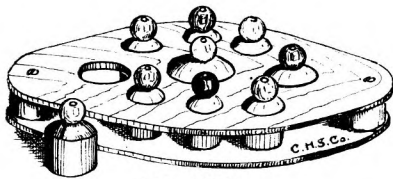

No. 36024.



No. 36252.

36024.	<b>Primary Cylinder Board</b> , McElwee's. A board or base carrying nine cylinders supplied with colored knobs. The cylinders are all of one height but varying diameters. (J.o.A.P. Aug. 1932:413-418) .....	5.00
36027A.	<b>Adaptation Board</b> . Pintner and Paterson's modification of the No. 36027 Vineland board, devised by Dr. H. H. Goddard. The board is somewhat smaller, while the holes are larger, and the wooden disk is supplied with a handle.....	5.00
36033.	<b>Color Mass Discrimination Test</b> , Philip's. Devised to investigate the relationship between speed and accuracy in a perceptual test. In addition to showing learning in a perceptual function, it illustrates certain Gestalt concepts in perception, and the effect of hue in dominance. The material is composed of 6 sets of 12 cards $2\frac{5}{16} \times 3\frac{3}{4}$ in., on each of which are dots in either of two colors. Each set forms a series to be graded according to predominance of color. The sets are printed in different pairs of colors, and coded on the reverse side. Complete in box.....	5.00
36041A.	<b>Maxim Test</b> , Kemp's (E.C.) Two sets of maxims, one of six and the other of ten, with the same number of sentences, to be identified with the corresponding maxim. Per 25.....	1.00
	Per 100 .....	3.00
36115.	<b>Purposive Thinking Test</b> , Garth's. A collection of twenty riddles, in two sections of ten each, for demonstrating that reasoning is, after all, trial-and-error procedure. About three minutes are required for the solution of each riddle. A set of answers is included with each order. (J.o.E.P. Jan. 1920:1-18). Per 25 sets.....	3.80
	Per 100 sets.....	11.40
36117.	<b>Analysis of Reasoning Apparatus</b> , Lazerte's. A piece of apparatus devised for use in the analysis of reasoning, which does on the ideational plane what the maze patterns do at the motor level. For illustrations and detailed descriptions of the apparatus refer to pp. 58-67 of "The Development of Problem-Solving Ability in Arithmetic" by M. E. Lazerte.....	45.00
36239.	<b>Color Preference Cards</b> , Metfessel's. A set of 28 cards, made up with Hering paper, for opaque projection. For studying the affective value of colors. (128:61; 128A).....	4.50
36252.	<b>Photographs</b> , Kline's. A set of 40, 20 showing the female face and upper portion of body with arms, and 20 showing the face only. Used for experiments in the identification of 20 body-face expressions of common emotions. (111:X106-108).....	12.00
36253.	<b>Photographs</b> , Frois-Wittmann. A series of 72 photographs, $2\frac{1}{4} \times 2\frac{1}{2}$ in., of the judgments of facial expression. In all the portraits, the face is clean-shaven, the head is held in a three-quarter position, and is tilted only when necessary for certain expressions. There is no indication of clothing, and there are no gestures by other bodily members. The facial expressions assumed by the model were those most natural to him or were imitations of those shown in other series of facial expressions which had already given significant results. The expressions were always assumed voluntarily and practiced in a mirror before photographing. (J.o.Ex.P. 1930, 13:113-151; 1935, 18:482-498). Per set.....	9.00
36254.	<b>Photographs</b> , Carmichael and Roberts. This set of 35 hands represents a carefully conducted study of emotional expression by means of the hands. The photography of the poses is very good. Each photograph carries the name of the emotion for which it was posed, also the name of the emotion it was judged to represent, on the back of the card. For example, No. 1 reads "Posed: Anger, Judged: Fear." No. 2, "Posed: Distrust, Judged: Quiet," etc. This set of photographs is not alone of value to the psychologist as indicators of the various emotions, but should also be of service to the teacher of public speaking and dramatics. (J.o.Ex.P., Aug. 1935: 482-498) .....	10.00

**INTELLIGENCE TESTS**

Number  
37008.

**Disk Test, Rosenstein's.** A base block with cover containing a disk cut into irregular sections and under-cut in a manner to make the disk very difficult to assemble. Norms are being gathered at the present time.....

Price  
\$ 24.00

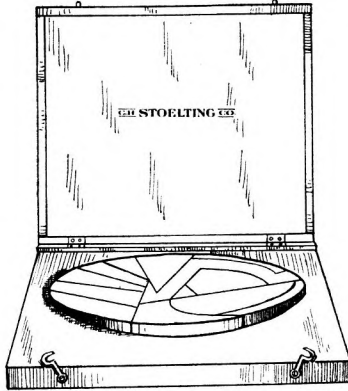

No. 37008.

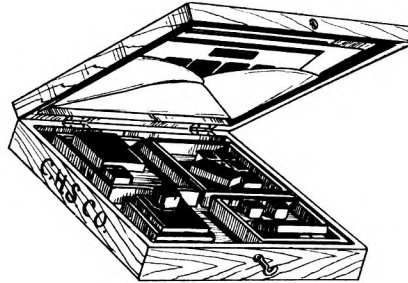

No. 37011.

- 37011. **"Passalong" Test, Alexander's.** A new performance test of intelligence consisting of a box approximately 8 in. square with trays varying in size, blue at one end and red at the other, containing a number of small colored blocks. Three trays contain a certain number of blue blocks and one or two red blocks. The subject's problem is to move the red block or blocks to the red end of the tray without lifting any of the blocks from the bottom. A set of nine cards of full size and colored in the same way as the blocks accompany each test so that when the subject starts a test he has before him a clearly defined goal toward which he has to strive. This test has a range of 7-16 years, inclusive, and is one of the few promising performance tests available for the higher age levels. (B.J.o.P. July 1932:52-63)..... 10.00
- 37011A. **Manual.** For No. 37011 Alexander's "Passalong" Test. This manual is a reprint of pages 52-63 of the British Journal of Psychology (General Section), Vol. XXIII, Part I, July 1932..... .45
- 44001. **Record Blanks, Alexander's, for No. 37011.** Per 25..... .45  
Per 100 ..... 1.35

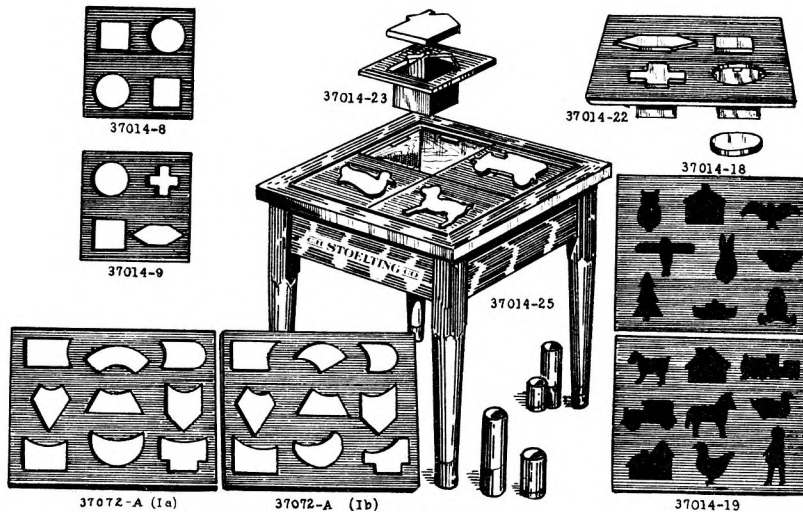

No. 37014.

- 37014. **Preschool Children's Tests, Skeels'.** The tests illustrated are taken from an extensive series of form boards, silhouettes and discrimination boards devised by Dr. Skeels for the testing of two and three year old children. In devising these tests Dr. Skeels has kept in mind the major factors related to form board performance and so developed meaningful objects that are reliable, attractive, and adequately motivating. The tests illustrated above are those recommended by Dr. Skeels and while a few of them, like the Goddard and Worcester Form Boards, have been incorporated in this series, the majority of the tests are almost wholly new and especially adapted to the testing of two and three year old children. All board surfaces

Number		Price
	have an antique ivory matte finish with recesses and insets a brilliant scarlet. A detailed account of the standardization of these tests, also instructions for administration and evaluation will be found in "University of Iowa Studies—Studies in Child Welfare." Vol. VII, No. II, New Series No. 249, April 15, 1933. Complete with 25 each of the Scoring Blanks.....	\$111.00
	Series I, Section C, Geometrical Form Board, one, large size (13½ in. x 18½ in.)	
27156.	<b>Form Board</b> , Seguin and Goddard (202:20, 34, 36, 37, 53-54).....	12.50
	Series II, Section A, Geometrical Form Boards, two, small size (6⅞ in. square)	
37014-8.	<b>Form Board</b> , with two each, circular and square insets. (202:20, 22, 54).....	3.75
37014-9.	<b>Form Board</b> , with one each circular, square, lozenge and Maltese cross insets. (202:20, 22, 33, 54)	3.75
	Series V, Worcester—Object Form Boards, two (10x12 in. and 7⅞ in. x 10¼ in.)	
37072-A.	<b>Form Boards</b> , Worcester, Shakow and Kent. The first two boards of the Worcester series with a set of nine insets apiece. (1a) bisymmetrical and (1b) asymmetrical. (202:24, 25, 54, 56, 62)	21.75
37014-18.	<b>Object Form Board</b> , with one each bisymmetrical insets representing cat, house, bird, airplane, rabbit, bowl, tree, ship, and baby. (202:24, 25, 48, 49, 62).....	6.00
37014-19.	<b>Object Form Board</b> , with one each asymmetrical insets representing dog, house, train, car, horse, duck, gable house, chicken, and girl. (202:24, 25, 51, 52, 62).....	6.50
	Series VII, Form Conditioning Series.	
37014-22.	<b>Form Discrimination Board</b> , Geometrical. Similar to drawing on page 27 of the "University of Iowa Studies" referred to above but provided with aluminum receptacles below each recess instead of a common floor board for all of them. (202:26, 28, 59, 61, 71-77).....	14.25
37014-23.	<b>Form Discrimination Board</b> , Object. Identical in size and construction with the No. 37014-22 above but is cut into four sections and uses a dog, duck, house and car instead of Geometrical Forms. (202:26, 28, 30, 63, 66, 69, 77, 78).....	15.50
37014-24.	<b>Blocks</b> , additional with dog (sitting), chicken, pitcher, cup, baby, bear, horse, cow, dog's head and a so-called "meaningless" body for use with No. 37014-23. (202:28, 30).....	3.00
37014-25.	<b>Table Standard</b> , consisting of four legs and a frame to hold the form discrimination board at approximately the same height so that the boards will be at the same height as when the child was working with the form board series. Two additional extensions for the table legs are supplied so that the height of the table frame may be varied according to the size of the child. (202:30, 43, 59, 63, 67, 68, 70, 75).....	17.50
37014-26.	<b>Chair</b> ; a child's chair to be occupied by the examiner opposite the child during the test. (202:43)	3.00
44068-7.	<b>Scoring Blanks</b> , Skeels'. For position one of the No. 27156 Seguin and Goddard Form Board. (202:36, 38, 79, 80.) Per 25.....	.75
	Per 100 .....	2.25
44068-7A.	<b>Scoring Blanks</b> , Skeels'. For position two of the No. 27156 Seguin and Goddard Form Board. (202:36, 38, 79, 80.) Per 25.....	.75
	Per 100 .....	2.25
44068-9.	<b>Record Blanks</b> , Skeels'. For No. 37014-9 Form Board. (202:36, 38, 79, 80.) Per 25.....	1.00
	Per 100 .....	3.00
44068-22.	<b>Record Blanks</b> , Skeels'. For No. 37014-22 Geometrical Form Board. (202:36, 38, 79, 80.) Per 25.....	.50
	Per 100 .....	1.50
44068-23.	<b>Record Blanks</b> , Skeels'. For No. 37014-23 Object Form Discrimination Board. (202:36, 38, 79, 80.) Per 25.....	.50
	Per 100 .....	1.50
37018.	<b>First-Year Mental Scale, California</b> . Devised by Dr. Nancy Bayley of the Institute of Child Welfare, University of California. The test schedule represented by this collection of tests has been selected and adapted from numerous sources. Mental status and mental development are somewhat more difficult to define and measure in early childhood than in later years and for this reason the need for another infant mental scale should not require a special emphasis. Parents and all agencies concerned with infant care may derive some advantage from an early prediction of subsequent mental status. Of greater importance, however, are the very numerous purposes in child development research for which a test instrument can be used during the first year of growth. Complete as listed below with 25 Record Blanks No. 44008 .....	73.82
37018-A.	<b>"The California First-Year Mental Scale,"</b> N. Bayley, No. 243 University of California Syllabus Series used as a manual for administering the scale.....	.55
37018-B.	<b>"Kiddie-Koop" Crib</b> .....	16.00
37018-C.	<b>Table</b> , ivory enameled.....	5.00
37018-D.	<b>High Chair</b> , with arms but no tray, for those who can sit alone.....	5.25
14349.	<b>Telegraph Snapper</b> .....	.20
27015-7.	<b>Embroidery Ring</b> , wood. Painted red, with white string.....	.70
37018-3.	<b>Incandescent Lamp</b> , red, two candle power "Christmas Tree," electric.....	.15
37018-4.	<b>Perimeter</b> , for use on the No. 37018-B Kiddie-Koop Crib.....	25.00
37018-5.	<b>Pencil</b> , yellow, hexagonal, full length, standard size.....	.10
37015-3.	<b>Teaspoon</b> , aluminum .....	.10
37015-4A.	<b>Cubes</b> , wood, set of 6, 1 inch, painted red.....	.15
37015-8.	<b>Paper</b> , 5½x8 inches; per 6 sheets.....	.10
37018-9.	<b>Rattle</b> , dumb-bell shape, about 15 cm. long.....	.50
37015-6.	<b>Bell</b> , nickel, with wood handle.....	.20
37015-11.	<b>Pellets</b> , sugar, white, per 200.....	.15
37018-12.	<b>Cup</b> , aluminum, 7 cm. high, 9 cm. in diameter at the top.....	.20
37018-13.	<b>Mirror</b> , 24x40 cm.....	1.50
37015-10.	<b>Crayon</b> , lumber, red.....	.15
37015-15.	<b>Form Board</b> , Gesell's, with circle, triangle and square.....	4.00

Number		Price
37015-14.	Doll, rubber, with whistle, 12 cm. high.....	\$ .25
37018-17.	Ball, red rubber, 5 cm. in diameter.....	.20
19207.	Peg Board, "A" Wallin's.....	2.25
37018-19.	Form Board, Bayley's.....	5.00
37018-20.	Picture Book, cloth, 15x22 cm., with colored pictures of "Pussies and Puppies".....	.70
37018-21.	Watch, Ingersoll "Midget".....	2.50
24836.	Scissors, "Kindergarten".....	.60
37018-23.	Box, 8x8x8 cm., with cover.....	1.20
44008.	Record Blanks, Bayley's, individual, per 25.....	1.12
	Per 100.....	3.35
37031.	Intelligence Test, Kent and Shakow. Designed for clinical use. A set of 7 tests, comprising (a) information (b) similarity (c) essential property (d) essential difference (e) arithmetical reasoning (f) sentence completion (g) hard directions test. This test was listed, incomplete, in the 1930 catalog. At the time of issue, there were only 4 of the tests available. (J.o.G'c.P., 1934). Per 25 sets.....	3.50
	Per 100.....	10.50
37047A.	Performance Scale, Arthur's. A collection of four additional tests comprising Nos. 27172, 27166, 27185, and 34054, for converting the No. 37047 set used for Form I into a collection that covers both Form I and Form II. (5A).....	29.75
37047B.	Performance Scale, Arthur's, Form II. Comprising the following: 1 each Nos. 33304, 27156, 27172, 27166, 27185, 34054, 37000, and 100 each Nos. 27124-27133, inclusive. (5A).....	54.05
37050.	Preschool Child Tests, Baldwin and Stecher. Complete set of all apparatus and material required by the book. (11).....	786.28
37058.	Mental Deterioration Test, Babcock's. This abridged form of the test is a combination test and manual, and was devised for use in hospitals for the insane, for the measurement of mental deterioration. The idea back of the examination is not whether the subject can do the things required, but to see how promptly he or she can comprehend the requests and carry them out. In addition to this test booklet or manual, a small supply of test material is required, and the requisite number of record blanks. The additional test material and record blanks are listed below. (Ar. of Psych., No. 117; J.o.A.a.S.P., April-June 1933.) Test booklet or manual only.....	1.00
31047.	Substitution Test, Pintner and Paterson. The upper half of the No. 31045 Woodworth and Wells Form Naming or Substitution test. Per 100.....	.80
33304.	Cube Imitation Test, Pintner's. Modification of the No. 33303 Knox Cubes. 53.5 cm. black cubes.....	1.25
32317.	Memory Test, Visual, U.S.A. Set of 5 cards, each having a different design.....	1.00
44004.	Record Blanks, Babcock's, for No. 37058. Per 25.....	2.50
	Per 100.....	7.50
37060L.	Stanford-Binet Scale, Revised, Terman and Merrill. A carefully finished wooden box with sliding top containing all of the printed card material and collection of miscellaneous items, most of them objects in miniature, attached to cards, form boards, cubes, etc., covering a range from the second year to adult levels, inclusively.....	8.00
37060M.	Stanford-Binet Scale, Revised, Terman and Merrill. An alternative test of the same type, with a similar complete set of materials.....	8.00
44041L.	Record Booklets, Terman and Merrill, for the No. 37060L Scale. Per 25.....	2.00
44041M.	Record Booklets, Terman and Merrill, for the No. 37060M Scale. Per 25.....	2.00
44042L.	Record Form, Terman and Merrill, for No. 37060L. Per 25. In preparation.	
44042M.	Record Form, Terman and Merrill, for No. 37060M. Per 25. In preparation.	
37061B.	Performance Tests, Randall's Island, Poul, Bristol, King, and Peatman. Devised for the examination of young children in psychological clinics. The range covered is 2-5 years. The tests as stated by the authors were selected from a mass of existing material with the idea of getting a series of tests that would hold the interest of the children and that would tie up with the Stanford-Binet-Simon Tests and also at the upper end with the Pintner and Paterson Performance Scale. The complete set as enumerated below, including Manual No. 46516. (174)	62.20
37000A.	Colored Cubes, Stutsman's.....	\$0.65
27241.	Nested Cubes, Stutsman's.....	.45
37015-4.	Block-Building Test (Gesell's Blocks).....	.25
33308.	Pyramid Test, Stutsman's. (May also be used for Block Building Test).....	.50
36026B.	Cylinder Test, Montessori's.....	7.50
27167.	Form Board, Two-Figure, Pintner and Paterson.....	5.00
25836.	Scissors, Kindergarten type.....	.60
19217.	Buttoning Test, Decroly and Stutsman.....	1.75
19207-S.	Peg Board A, Wallin's.....	2.50
19208-S.	Peg Board B, Wallin's.....	3.50
19237.	Stick and String Test, Stutsman's.....	.25
33304.	Cube Imitation Test, Knox's.....	1.25
27171.	Matching Game, Decroly's.....	1.50
37094.	Comprehension Test, Roback's, 1930 Edition. Devised to be used in connection with No. 37093 Superior Adult Test listed on page 177 of the 1930 edition of our general catalog. A series of Interpretation, Application, Analysis, and Characterization Tests. This test requires four different approaches. Per 10.....	2.50
	Per 100.....	15.00
46536.	Manual, Roback's. For No. 37094 Comprehension Test.....	.20
27158.	Form Board, Seguin, Goddard and Sylvester.....	15.00
36027.	Adaptation Board, Vineland.....	4.50
12313.	Color Matching Test, Stutsman's.....	.60
39024.	Number Concept Test, Baldwin and Stecher.....	.50
27170-S.	Manikin Test, Pintner's.....	3.75
27152.	Picture Form Board, Stutsman's, No. 1.....	3.50
27163.	Picture Form Board, Stutsman's, No. 2.....	3.50
27165.	Picture Form Board, Stutsman's, No. 3.....	4.00
	Report Blank, Poul's. (Obtain from Columbia University Press)	

Number		Price
<b>39006A.</b>	<b>General Information Score Sheet</b> , Papurt's. This is one of a series of tests standardized by the Department of Correction of the State of New York. This test is based upon items of general information and consists of one hundred questions to be answered by the subject. It has been standardized upon 3000 inmates of the various penal institutions of New York State as well as on controlled groups of non-criminals. This test may be given individually or as a group test. With illiterates or foreigners the answers may be written in for the subject. It will be noticed that in several instances academic correctness has been sacrificed for clarity of meaning. While a time limit of 30 minutes has been set, this test is not essentially a speed test. Per 25.....	\$ 2.50
	Per 100 .....	7.50
<b>39006B.</b>	<b>Manual</b> , Papurt's. For No. 39006A General Information Score Sheet.....	.35
<b>39023.</b>	<b>Attainment Scale for Clinical Use</b> , Wallin's. A brief scale, consisting of exercises in reading, written language, arithmetic, and phonetic spelling. Originally standardized on 491 children in grades 1-3 and later restandardized on the basis of 579 additional testings of children from the same grades. Continued use of the scale in psycho-educational, psychological, and child guidance clinics for several years has demonstrated its practicability and value in the examination of normal or deficient children whose educational competency does not exceed the Third Grade level. By its use an approximately correct grade placement can be made in a few minutes of children who come to the clinic without a satisfactory educational record or without the ratings from group educational tests. (246:441-489).....	.50
<b>44043.</b>	<b>Record Blanks</b> , Wallin's. For the No. 39023 Attainment Scale for Clinical Use. Per 25.....	1.00
	Per 100 .....	3.00
<b>39031A.</b>	<b>Recreational Interview</b> , Wannamaker's. Devised for the Illinois Institute for Juvenile Research. The purpose of this interview is to secure information concerning the individual's use of his leisure time; to gain an insight into his recreational likes and dislikes; and the reasons underlying them; to understand the individual's social relationships and his conception of his status in the groups to which he belongs. The interview was not devised to obtain information in regard to family or behavior difficulties, although voluntary statements of this nature should not be disregarded. Because of the flexibility in the use of the interview, it is not adapted to statistical investigations on a broad scale in which uniformity in presentation is essential. Its use is especially recommended to social workers, visiting teachers, psychiatrists, and group workers in securing information on an individual basis; in obtaining side-lights on personalities; and in establishing a friendly relationship with the person interviewed. For years 9-16, per 25.....	5.00
	Per 100 .....	15.00
<b>39031B.</b>	<b>Recreational Interview</b> , Wannamaker's; 17-21 years. Per 25.....	5.00
	Per 100 .....	15.00
<b>39031C.</b>	<b>Recreational Interview</b> , Wannamaker's; Adult. Per 25.....	3.35
	Per 100 .....	10.00
	<b>Religious Aptitude Tests</b> , Wilson's. All of these tests are constructed to measure the aptitude of mankind for religion. They are not tests of any particular faith. The belief of modern science that anything which is real can be measured, led to the construction of various tests which gave a numerical value to the essential traits of human beings. Individual differences occur within these fundamental traits. Aptitude for religion is a trait of mankind similar to intelligence or musical talent. This aptitude may be measured in the same precise manner in which a few human traits already have been observed. The capacity which one has for religion may be determined in such a way that a person is able to secure knowledge of the strength of this talent in him. Such information should enable that person better to promote his own welfare. The main test in this series, A Test of Religious Aptitude, is graded for both high school students and college students. The special tests, A Test of Religious Aptitude Concerning People, and also A Test of Religious Aptitude Concerning Nature, developed from the discovery that people and nature are very important bearers of religious experience. Hence, they both may be used to measure the aptitude which one has for religion. The special tests are graded for college students. All of this series of tests has satisfactory validity and reliability.	
<b>39060A.</b>	<b>A Test of Religious Aptitude</b> , Wilson's. Test I. Per 25.....	2.25
	Per 100 .....	6.75
<b>39060B.</b>	<b>A Test of Religious Aptitude Concerning People</b> , Wilson's. Test II. Per 25.....	1.00
	Per 100 .....	3.00
<b>39060C.</b>	<b>A Test of Religious Aptitude Concerning Nature</b> , Wilson's. Test III. Per 25.....	1.50
	Per 100 .....	4.50
<b>39060M.</b>	<b>Manual</b> , Wilson's, for Nos. 39060A, B and C.....	.45
<b>40017.</b>	<b>Occupational Inventory</b> , Simpson's. This inventory was devised in the Division of the Criminologist, Dept. of Public Welfare, State of Illinois, and is extensively used in the penal institutions, Illinois Free Employment Agency, the Psychiatric Clinic of the Chicago courts, and a number of other institutions under the supervision of the Department of Public Welfare. The present form of the inventory is an outgrowth of the original inventory published in 1923, entitled "Outline of Occupations," by Simpson and Turman, for a survey course in occupations in the Joliet Township High School. It is a very practical blank for securing an insight into the work experience and aptitude of the male. It covers (1) Plant and Animal Supply; (2) Manufacturing, Extraction, and Preparation; (3) Distribution and Trading; (4) Transportation; (5) Communication, Light, Heat, and Power; (6) Building Trades; (7) Public Service; (8) Personal Service; (9) Professional Work; (10) Entertainment; and (11) Work Summary. Per 25.....	3.35
	Per 100 .....	10.00

Number		Price
<b>40020A.</b>	<b>Occupational Interest Blank</b> , Freyd's; Hubbard's modification. Used as part of the Minnesota mechanical abilities project. (P.S.a.J.o.G.P. 35, 1928:229-254; 154:121-125). Per 25.....	\$ .95
	Per 100 .....	2.85
<b>40023.</b>	<b>Educational Information Test</b> , Brewer and Lincoln. This test measures the breadth and accuracy of the pupil's information and good sense in regard to educational matters, such as the purpose of school subjects, the educational and vocational possibilities of this type of curricula, and the educational requirements of various occupations. It is planned for the following uses: (1) to estimate whether or not the pupil is ready for important educational decisions; (2) to test the informational background upon which such a decision has been made; (3) to serve as a basis for instructional information and enlightenment on items of educational success; and (4) to serve, particularly after it has been filled out, as a basis for class discussion. It is particularly suitable for pupils in the later years of junior high school and for the first years of senior high school, and it may be profitably used among older students to show the need for further educational enlightenment. The test should be especially useful for all counselors and deans who deal with individuals. Spearman Brown formula "Co-efficient of Reliability .8276, Standard Deviation .0151." Per 25.....	2.50
	Per 100 .....	7.50
<b>40023A.</b>	<b>Instructions</b> for administering and scoring and a key for the No. 40023 Educational Information Test .....	.20
<b>40024.</b>	<b>Vocational Information Test</b> , Brewer and Lincoln. This test deals with items of information and judgment about occupations such as the tasks carried on by various workers, and the education, training, and other qualifications needed in different lines of work. It is broad in scope and not confined to any particular textbook or course of study. It is useful (1) as a teaching device for giving essential enlightenment about occupational life; (2) as a basis for class discussions; (3) as a means for measuring the scope of a pupil's information in preparation for his own vocational decision; (4) as a diagnosis of the level of occupational enlightenment for any particular individual, class, or group; and (5) as a test of the effectiveness of the instructional work in the class in occupational information. This test is suitable for the later years of junior high school and the first year of senior high school, as it may be used wholly or in part in other grades to show the need for further enlightenment. The test is particularly valuable for use in the offices or waiting rooms of counselors and furnishes a good basis for educational and vocational counseling. Spearman Brown Formula, "Co-Efficient of Reliability .8863, Standard Deviation .0086." (S.a.S. Jan. 16, 1926.) Per 25.....	2.75
	Per 100 .....	8.25
<b>40024A.</b>	<b>Instructions</b> for administering and scoring and a key for the No. 40024 Vocational Information Test .....	.20
<b>40025.</b>	<b>Self-Measuring Scale</b> , Brewer's. For achievement and experience in work and education. This scale offers the opportunity for the self-appraisal of the student and is based on a large number of tasks in the various fields of occupational efforts. Tasks in agriculture, industry, homemaking, commerce, and the professions are indicated, and the scoring method favors breadth and versatility. This scale is adapted to junior high school students. It is particularly useful in enabling the counselor to make an appraisal of the experiential background which the pupil has for his tentative vocational choices. Per 25.....	2.50
	Per 100 .....	7.50
<b>42028.</b>	<b>Arithmetical Test, Machine Tool Operators'</b> , Link's. For testing the mathematical ability of applicants. Per 100.....	.80

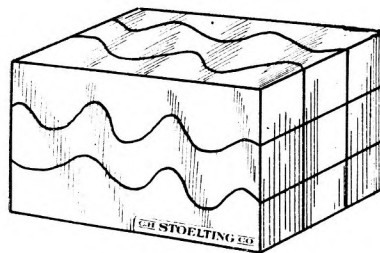

No. 42042.

<b>42042.</b>	<b>Wiggly Block</b> , O'Connor's. A Chinese puzzle used by Mr. Johnson O'Connor, of the Stevens Institute of Technology, as Work Sample No. 5 in testing mechanical aptitude. It consists of nine irregular wave-like pieces which when assembled form a solid block approximately 5 7/8x5 7/8x10 in. (62A:C3; 150:27-36, 209-213; 150A; Amer. Mag., Aug. 1931; Forum, 1931; Atlantic Monthly, June 1931; 187A:T124).....	18.00
<b>42046.</b>	<b>Detroit Manual Ability Task (Arbeits-Prüfung)</b> , Crockett's. This manual ability task was designed to meet the need for a practical measure of productive ability. The idea of the test was obtained from a study of production records in an adding machine company. Some men were consistently high producers; some were consistently low. This was true of such operations as are found in running a drill press, hand screw machine, milling machine, and external grinder. (To distinguish the manual ability task from the usual simple motor tests and the slightly more complex form boards, it has been given the German term "Arbeits-Prüfung," literally translated meaning "work-examination." The term suggests a complex task that has been well standardized.)	

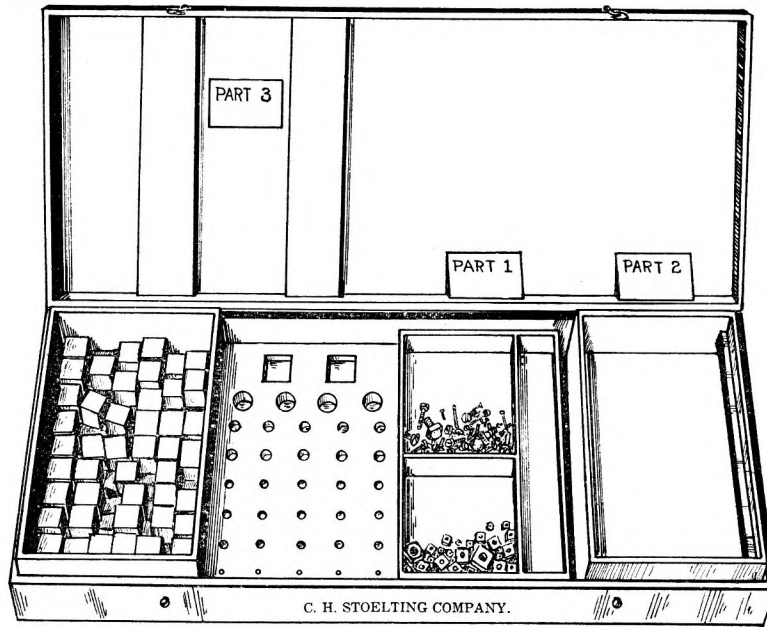

No. 42046.

Number

Price

The task is composed of three types of work. The first type involves screwing nuts and bolts of varied sizes together. The second type requires a packing of blocks from one box to another. The third type calls for the precise placement of blocks upon a strip of wood. The first part measures the ability of eye and hand to work together, when movements of small amplitude are involved, and where a premium is placed upon visual acuity. The second part measures movements of larger amplitude involving the arms, as well as the fingers. The third part tests accuracy as well as speed of movement, with amplitude of intermediate degree. The first part emphasizes twisting, the second thrusting, the third claspings. From this brief discussion, it will be seen that the task as a whole may be said to tap the various motor processes in action. The three tasks are sufficiently common so that the subject does not sense the freakish effect so often characterizing tests. The results show that there is a wide range of manual ability at different age, educational, and intelligence levels. Standards have been prepared for 1021 persons: 496 boys and 525 girls, with an average age of 16.8 years. The standards have been developed for each of the three parts of the test as well as the total scores. The results may be expressed graphically upon the chart prepared for that purpose. The test is of particular interest to the observer in the psychological clinic, to the industrial psychologist, and to the teacher in manual arts courses. (J.o.A.P., Oct. 1930:414-426)

<p>42046A. <b>Manual</b>, Crockett's. For the No. 42046 Manual Ability Task. ....</p> <p>42046B. <b>Instructions</b>, Crockett's. For individuals taking No. 42046 Manual Ability Task. Per 25.....</p> <p>Per 100 .....</p> <p>44006. <b>Record Blanks</b>, Crockett's. For the No. 42046 Manual Ability Task. Per 25.....</p> <p>Per 100 .....</p> <p>42047R. <b>Assembly Test for Girls</b>, Burr and Metcalfe's. A revision of the I.E.R. Assembly Test devised by Dr. H. A. Toops, and the staff of the Division of Psychology, Institute of Educational Research, Teachers College, Columbia University. This abridged form of the test includes the following 7 items: B, inserting tape; C, making rosette; D, cross-stitch; F, assembling chain of clips; G, tape-sewing; I, card-wrapping; K, trimming paper. The test, in its present form, requires 30 min., while the original form was given with a 45 min. time limit, and scoring and replacement of material for the next examinee required about 15 min. additional. When given individually, without a time limit, some individuals took nearly 3 hours to complete the test. (A.J.o.P.: Vol. 20, Jan. 1937; 11B).....</p> <p>42047X. <b>Replacement Material</b> for giving 25 additional abridged I.E.R. tests.....</p> <p>42047Y. <b>Replacement Material</b> for giving 50 additional abridged I.E.R. tests.....</p> <p>42047Z. <b>Replacement Material</b> for giving 100 additional abridged I.E.R. tests.....</p> <p>44075R. <b>Score Cards</b> for No. 42047R. Per 25.....</p> <p>Per 100 .....</p> <p>42052. <b>Blueprint Reading Test</b>, Newman's. A practical test used in the Employment Department of a large manufacturing organization. The test is graduated to test at about the level of ability required of machine specialists, such as lathe hands, boring-mill operators, and screw-machine operators. It is not designed to test engineers or draftsmen. The drawing, which has been purposely made to include a number of errors, is presented to the applicant to read, the assumption being that a person possessing the degree of blueprint reading ability required will be able to point out most of the errors. (F.a.I.M., Feb. 1932:75.) Per 100 .....</p>	<p>\$ 15.00</p> <p>.50</p> <p>1.00</p> <p>3.00</p> <p>.50</p> <p>1.50</p> <p>4.35</p> <p>2.35</p> <p>4.05</p> <p>6.90</p> <p>1.00</p> <p>3.00</p> <p>2.00</p>
----------------------------------------------------------------------------------------------------------------------------------------------------------------------------------------------------------------------------------------------------------------------------------------------------------------------------------------------------------------------------------------------------------------------------------------------------------------------------------------------------------------------------------------------------------------------------------------------------------------------------------------------------------------------------------------------------------------------------------------------------------------------------------------------------------------------------------------------------------------------------------------------------------------------------------------------------------------------------------------------------------------------------------------------------------------------------------------------------------------------------------------------------------------------------------------------------------------------------------------------------------------------------------------------------------------------------------------------------------------------------------------------------------------------------------------------------------------------------------------------------------------------------------------------------------------------------------------------------------------------------------------------------------------------------------------------------------------------------------------------------------------------------------------------------------------------------------------------------------------------------------------------------------------------------------------------------------------------------------------------------------------------------------------------------------------------------------------------------------------------------------------------------------------------------------------------------------------------------------------------------------------	---------------------------------------------------------------------------------------------------------------------------------------------------------------

Number

Price

**42053. Micrometer Reading Test, Newman's.** This test is somewhat similar to the blueprint reading test, except that errors have not been used in its construction. The test shows pictures of various kinds of micrometers, ranging from simple standard micrometers to the more difficult types which read in ten-thousandths of an inch. Depth micrometers and inside and outside types are pictured in order to make the test difficult enough to test even the highest level of ability, but (except in the case of toolmakers and other skilled specialists) the ability to read simple standard micrometers is all that is required and therefore all that is tested. The pictures are arranged in the order of their difficulty; the easier types are encountered first and the most difficult types later on. This serves as a "shock-absorber" to the nervous applicant by starting him on problems of easy accomplishment. (F.a.I.M., Feb. 1932:75)  
Per 100 .....

\$ 2.50

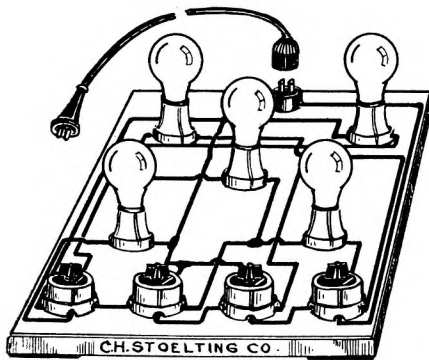

No. 42056.

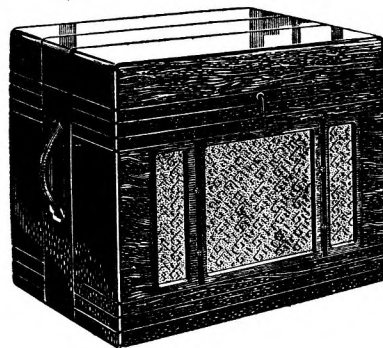

No. 20252E.

**42056. Electric Circuit Tracing Test, Philip's.** This is a performance test suitable for adults, though it has been satisfactorily used with children of eighth grade level. It does not require electrical experience beyond that conveyed in the simple instructions, and seems as well suited for women as for men. It presents alternative problems for solution, and each problem requires but a few minutes. It has been standardized on several hundred subjects, chiefly men and boys. The apparatus consists of a mahogany finished wood base, 15 in. square, on which is mounted a series of 5 incandescent lamps, 4 button switches, and a plug receptacle for connecting to the 110 Volt lamp circuit. The connections are all visible and firmly stapled to the board. The problem to be solved is the lighting of the designated one of 5 lamps, after studying the exposed connecting wiring and the appropriate setting of 4 four-way switches, by which the lamps are interconnected. Fundamentally the test presents a concrete problem involving a minimum of technical knowledge which must be thought through in spite of the changing difficulties. It is as it were a mental maze. This test has been used for vocational guidance, and does seem to select those subjects who have ability for technical, engineering and scientific vocations. (J. o. A. P., Vol. XIX, No. 2, 1934:148-165).....

14.25

**42059. Sound Effects and Elimination of Overtones.** A phonograph record from the Department of Psychology, University of Southern California. This is a double-faced record 12 in. diameter and carries on one side an illustration of the properties of auditory stimuli, and on the other an illustration of the importance of the fundamentals and various overtones in speech and music. The first face referred to is in five parts. (1) Pitch, intensity and timbre differences. Noise. (2) Sound interferences—beats and difference. Tones. (3) Overtone analysis from sonometer. (4) Tone mixing—Sonance. (5) Sounds of action currents from the forearm in clenching the fist. The second face is divided into six parts. (1) Music with a normal range of frequency. (2) Fundamental tones below 400 d. v. suppressed by electrical filters. (3) Suppression of all tones below 100 d. v. (4) Normal range of frequency to provide a fresh basis for comparison. (5) Suppression of all tones above 2000 d. v. (6) Suppression of all tones above 1000 d. v. The subjects are asked to record what happened to the intensity and quality of the sound during the attenuation of the various ranges of frequencies. This record was produced under the direction of Dr. Metfessel with the co-operation of Mr. Frederick Lindsey, the Southern California Telephone Company and Mr. Paul L. Dobson (128:25-29) .....

2.75



Number		Price
<b>44040B.</b>	<b>Record Blanks.</b> For use with the No. 42059 Phonograph Record. Per 100.....	\$ 2.25
<b>42062.</b>	<b>Musical Discrimination Test, Oregon.</b> This test consists of 3 double-faced and 1 single-faced record carrying 48 piano excerpts of an extensive range of musical compositions of unquestioned merit from the leading composers, each accompanied by a mutilation of some kind affecting harmony, melody, rhythm or form, which destroys the merit of the original composition. After hearing the original and the mutilation, the subject is asked to record on an especially prepared blank his choice, also his idea of what was changed in the rejected selection that makes it inferior. When the 48 auditions have been completed, the subject is scored as follows: one credit is given for the correct choice of each of the 48 original excerpts and an additional credit of one for the detection of the type of mutilation present in the rejected selection. Studies conducted by the author, Kate Hevner, Ph.D., with the assistance of R. H. Seashore, Ph.D., and John L. Landsbury, Mus.D., on more than 2000 subjects, have yielded highly satisfactory results. The test should be of value to teachers of music appreciation and may be used as a standard for measuring progress in music appreciation as well as a device for analyzing the mental processes of the appreciation experience. The test is one of several completed under a financial grant of the Carnegie Foundation, for the advancement of teaching at the University of Oregon, in collaboration with the music committee of the University..	
<b>42062A.</b>	<b>Manual,</b> Hevner's, for administering and evaluating the No. 42062 Musical Discrimination Test	.25
<b>44040.</b>	<b>Record Blanks,</b> Hevner's, for making a detailed record of the individual tested. Per 100.....	2.25
<b>44040A.</b>	<b>Stencils,</b> Hevner's. For No. 44040 Record Blanks.....	2.00
<b>17109.</b>	<b>Phonetic Discrimination Test, Mooseheart.</b> This test was worked out in the Mooseheart Laboratory for Child Research by James A. Carrell, Ph.D., Research Associate, under the direction of Dr. M. L. Reymert, as an additional clinical aid for the Speech Pathological Division of the laboratory. This test consists of one double face 12 in. record, containing the speech sounds presented by the method of paired comparisons. It is designed as a convenient clinical aid to the evaluation of the possible etiological significance of auditory factors in cases of functional speech disorders, particularly those involving sound substitutions. Speech pathologists have long recognized that a general loss in auditory acuity and a specific lowered efficiency in the discrimination between sounds are important in the understanding of functional speech disorders. Considerable evidence is available to indicate that many individuals having sound substitutions are inferior in ability to make auditory discriminations between sounds. The speech defectives also often fail in discriminating those sounds which are involved in substitutions. In searching for the possible causes of the disorder in cases of sound substitutions, the speech pathologist or teacher is therefore interested in determining whether or not the patient is deficient in his ability to recognize the difference between the correct sounds and the ones which he chooses as substitutes in his speech. For instance, a lisper may not discriminate between th and s. If discriminatory ability is poor, this factor is generally made the first point of attack in planning a remedial program. The Mooseheart Phonetic Discrimination test offers phonographic presentation of the sounds as an objective, rapid, and convenient method of testing discrimination ability. One hundred pairs of sounds are presented by the method of paired comparisons and the subject in each case is required to judge whether the sounds are the same or different. In addition to the test score, which gives general information about the discriminatory ability of the subject, the examiner may determine specifically those sounds which are misheard. Since the stimulus pairs are kept constant with respect to inflection, pitch, and intensity, a highly accurate and reliable measure is provided. The Mooseheart Phonetic Discrimination test has the further advantage that it may be given to large groups of subjects in the classroom, and so far as the mere administration of the test is concerned, no special training is required of the examiner.....	
<b>17109M.</b>	<b>Manual,</b> for No. 17109 Mooseheart Phonetic Discrimination Test.....	.35
<b>17109R.</b>	<b>Record Blanks,</b> for No. 17109 Mooseheart Phonetic Discrimination Test. Per 100.....	1.50
<b>20252E.</b>	<b>Electrola</b> (RCA Victor—without radio). A low cost phonograph designed for educational use in music appreciation, its integration with other studies and its creative interpretation. Three-tube amplifying system and 2 watts undistorted output. Excellent tone quality and a surprising degree of volume for so small an instrument. Electro-dynamic speaker, 8 in. in diameter; electric motor 110 volt A.C. operated. Reproduces 10 and 12 in. records. Plays with lid closed or open. Power switch—volume control knob located on the motorboard. Turntable locked on—cannot fall off while being carried. Removable power cord which plugs into receptacle in cabinet. Lid has special latch for carrying convenience. Height, 13½ in.; width, 15½ in.; depth, 13 in.; weight, 29 pounds.....	49.95
<b>42063R.</b>	<b>Clerical Test,</b> Moore's. A modification of the well-known clerical test No. 42063, devised by the National Institute of Industrial Psychology (Series 25), adapted for use in American commercial and industrial organizations. (T.H.F., Vol. 7, No. 11, Nov. 1933.) Per 25.....	2.50
	Per 100 .....	7.25
<b>42063S.</b>	<b>Manual</b> for No. 42063R Clerical Test.....	.10
<b>42064A.</b>	<b>Form Board, AA, Paper,</b> Likert and Quasha. This test is a revision of the Minnesota paper form board and was prepared with a view toward simplifying the scoring system used on the Minnesota test. This revised test, in addition, is more reliable and more objective, and can be scored more than 10 times as fast as the original. It has been found, on the basis of several hundred cases, to correlate with the original test almost as high as the reliability of the two tests. The test is a six-page test in the shape of a folder printed on heavy paper. Per 100.....	4.45
<b>42064B.</b>	<b>Form Board BB, Paper,</b> Likert and Quasha. An alternate form for use where one has reason to suspect coaching or a retentive memory on the part of the subject who has taken the Form A test. Per 100.....	4.45
<b>42064M.</b>	<b>Manual,</b> for Nos. 42064A and B. This manual contains instructions for administering and scoring, also norms for both forms.....	.10
<b>42066D.</b>	<b>Scoring Sheets.</b> For Nos. 42066A and 42066B Minnesota Paper "Form Boards." (154).....	3.50

Number		Price
42069.	<b>Finger Dexterity Apparatus, O'Connor's.</b> This is "Worksample No. 16" and consists of a metal plate, 5¾ in. wide by 12 in. long with one-half recessed in order to form a shallow tray and the other half drilled with 100 holes, arranged in 10 lines of 10 each. A supply of 310 brass pins is provided for inserting in the holes. This quantity provides a sufficient number to render unnecessary the spending of time in recovering any that may be dropped during the test. (150:21, 23, 54-56, 62, 64, 65, 173, 178, 181-186, 188, 194-198, 201-203, 213-215).....	\$ 25.00
42070.	<b>Tweezer Dexterity Apparatus, O'Connor's.</b> A metal plate of the same size as No. 42069, but with holes of a different diameter, and designed to take only one pin each of the size supplied with the No. 42069. This is "Worksample No. 17." A tweezer and a supply of 105 brass pins are provided in order that a reasonable number of the pins may be dropped without taking time out to recover them. (150:56-59, 64, 65, 174, 179, 180, 185-199, 201-203, 215-217).....	\$ 20.00

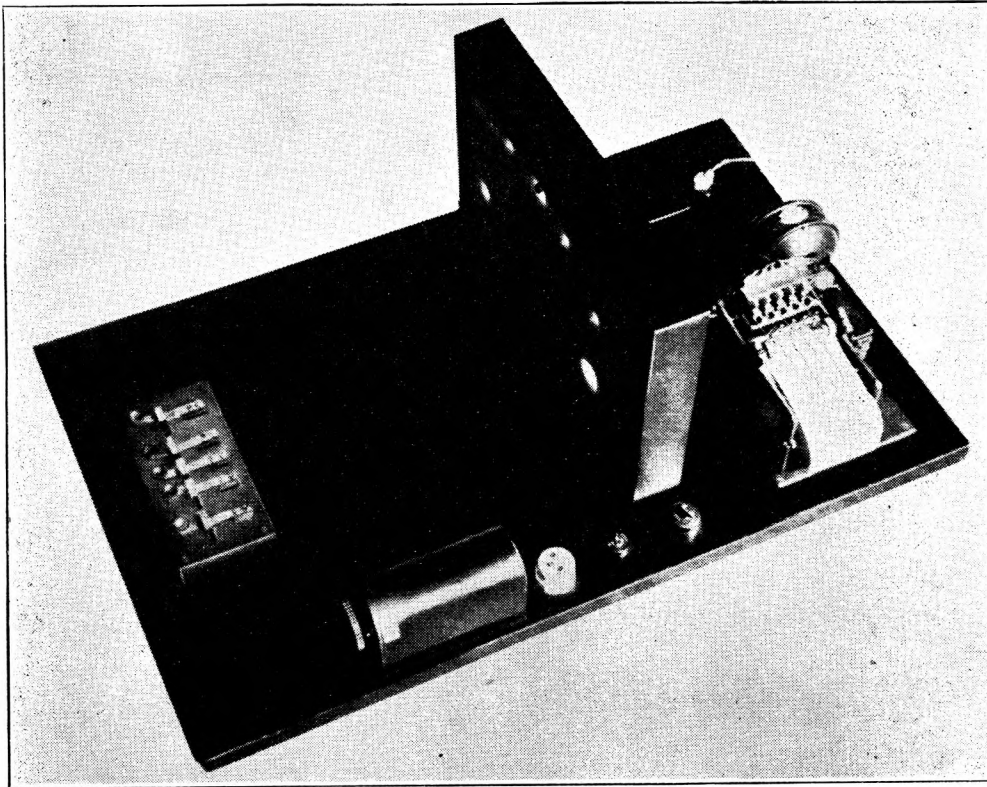

No. 42075.

42075. **Multiple Choice Reaction Test, Forster's.** A test for the selection of competent operators of automobiles, street cars, buses or airplanes, devised by Dr. William Forster, a technopsychologist and engineer of Praha, Czechoslovakia. As the operation of a motor-propelled vehicle is impossible without some degree of training, the testing of this aptitude, like most others, resolves itself into the construction of a test that will correspond closely with the conditions of the actual performance. This does not mean that the actual performance must be duplicated in miniature or otherwise, but it does mean that the psychological construction of the performance must be preserved. This apparatus shows a high correlation with aptitude for the operation of motor driven vehicles and invariably elicits the performance of all the necessary reactions to the complex situations in which the rapidity and accuracy of movements depend on the abstraction of a reflex pattern from a whole complex sensory percept. In the words of a well-known psychologist, "If the test records, and ability for any particular type of work, show a high positive correlation so that an individual who is found to be good, medium or poor in the one is, as a matter of fact, also found to be good, medium or poor in the other, then, without further analysis, the one maybe used as the sign of the other." The subject is seated before the apparatus within reach of the five keys shown at the left. The three middle keys are black topped, and correspond to each of the three vertical fields shown on the upright support back of the keys. Beside these three middle keys, there is a white topped key to the right and a red topped key to the left. The instructions given to the subject are as follows:
- "You see before you three fields. On each of these fields lights of various colors will be displayed. You will have three tasks to perform which will now be enumerated.
- First task: When you see on any of the fields two lights of the same color press down the key belonging to that field. When lights of the same color appear on two fields press down the two corresponding keys.
- Second task. When, on any of the fields, a white light (warning light) appears, press down the white key on the right, and at the same time press down the key that corresponds to the field on which the white light is shown.

Number		Price
	<p>Third task. When a signal appears that requires no reaction, that is, when neither two lights of the same color, or the white light appear, press down the key placed on the left (negative reaction) in order to show that you were attentive, but did not perceive anything requiring action."</p> <p>The advantages of this apparatus are many. The test combines 24 reactions arranged in an order described in detail in the instructions. The reactions are all recorded electromagnetically on a band of paper moving at a constant rate of 1 cm. per second. Each key is connected with a pen which, when the key is depressed, makes a tracing. The time of exposure of the signal may be ascertained from the tracing left behind on the five lines that correspond to the individual pens, and, as we know by which of the keys the several signals are recorded, we easily read off from the record the moment at which the corresponding pens returned to their normal position, that is, the moment at which the right and complete reaction has been discharged. Then we measure on the record the times of all the 24 reactions, add them and divide the same by 24, thus obtaining the average reaction time. The whole process of calculation does not take more than five minutes.</p> <p>The apparatus also helps us to ascertain the subject's power of resisting fright and emotional excitement. Usually the emotion of fright introduces into the experiment a set of heterogeneous and disturbing stimuli. We remain calm as long as the results of our activity fit our expectations, but when an effect occurs for which we are not prepared, then the energy liberated by the impression does not combine at once its efferent channel and tends to diffuse itself through the complex of sensory and motor centers that are dynamically connected with the centers directly affected by the stimulus. These centers lose the capacity of differentiated integration of the nervous impulses and what ensues is a disturbance of the correctness and accuracy of the performance controlled and coordinated from these centers. Emotional excitement is always accompanied by some disturbance of the bodily functions and leads to confusion. These disturbances are readily recorded by the apparatus.</p> <p>When the motor reaction results in a foreseen effect, the lights go out and the work goes on smoothly without hesitation, but when the expected effect does not occur and the lights continue to shine, mental confusion results. This confusion manifests itself, as a rule, in two types of action (a) bewilderment, the subject depresses the keys without order or reflection as if out of his senses; (b) torpor, the subject actually becomes entirely paralyzed and he is, for a time, incapable of any action or decision at all. A mental confusion always manifests itself in a disproportionately prolonged reaction time.</p> <p>The order of signals in our apparatus is arranged in such a way that certain critical combinations of lights must readily throw the subject into confusion. A copy of Dr. Forster's article entitled "A Test for Drivers," which appeared in the "Personnel Journal," Vol. VII, No. 3, October, 1928, is supplied with each apparatus. This article gives all the details for administering and evaluating the results.....</p>	\$800.00
42076A.	<b>Engine-Lathe Test Blank</b> , Newman's. For use with the No. 42076 Engine-Lathe Test. It is designed to discover the applicant's ability to operate a lathe, milling machine or profiler. For illustration and description of Hull's apparatus, see pages 188 and 189 of our catalog. (F.a.I.M., Feb. 1932:75). Per 100.....	1.00
42082.	<b>Teachers' Judgment in Child Discipline Test</b> , Scheidemann's. This test consists of summary statements of situations often encountered by parents and teachers. With each are four statements pertaining to the situation. The statements are preceded by a "T" and an "F." If the subject thinks the statement true, the "T" is encircled; if false, the "F" is encircled. Per 25 .....	2.00
	Per 100 .....	6.00
42082A.	<b>Manual</b> , Scheidemann's. For the No. 42082 Teachers' Judgment in Child Discipline Test.....	.25
42083.	<b>Teachers' Professional Judgment Test</b> , Scheidemann's. Teachers are constantly encountering situations that challenge their professional judgment. In this test summary statements of general situations are presented; factors that characterize particular situations are not given. On the basis of the meager information given, the individual is asked to answer the questions as directed in order to see how nearly his responses coincide with those of the successful educators who have answered the questions. Per 25.....	2.00
	Per 100 .....	6.00
42083A.	<b>Manual</b> , Scheidemann's. For the No. 42083 Teachers' Professional Judgment Test.....	.20
<b>RECORDING BLANKS—BINDERS</b>		
44001.	<b>Record Blanks</b> , Alexander's. For No. 37011 "Passalong" Test. Per 25.....	.45
	Per 100 .....	1.35
44002.	<b>Record Blanks</b> , Atkins'. Revised scoring sheet, combining forms A and B. For No. 37073 Object-Fitting Test. Per 25 .....	1.40
	Per 100 .....	5.60
44003.	<b>Scoring Cards</b> , Arthur's. For Form I of "A Point Scale of Performance Tests." Per 25.....	1.00
	Per 100 .....	3.00

Number		Price
44004.	<b>Record Blanks, Babcock's.</b> For the No. 37058 Mental Deterioration Test. Per 25.....	\$ 2.50
	Per 100 .....	7.50
44006.	<b>Record Blanks, Crockett's.</b> For the No. 42046 Manual Ability Task. Per 25.....	.50
	Per 100 .....	1.50
44008.	<b>Record Blanks, Bayley's.</b> For the No. 37018 First-Year Mental Scale, California. Per 25 .....	1.12
	Per 100 .....	3.35
44026.	<b>Record Blanks, Monroe's.</b> For the No. 17120 Diagnostic Reading Examination. Per 25.....	2.25
	Per 100 .....	6.75
44030.	<b>Record Blanks, Marston's.</b> For No. 24545 Children's Extroversion-Introversion Test. (123:21-23). Per 25 .....	1.00
	Per 100 .....	3.00
44033.	<b>Record Blanks, Ontario Hospital, Orrilia, Canada.</b> For Porteus Mazes. Per 25.....	.45
	Per 100 .....	1.25
44040.	<b>Record Blanks, Hevner's.</b> Per 100 .....	2.25
44040A.	<b>Stencils for No. 44040 Record Blanks</b> .....	2.00
44040B.	<b>Record Blanks.</b> For use with the No. 42059 Phonograph Record. Per 100.....	2.25
44043.	<b>Record Blanks, Wallin's.</b> For the No. 39023 Attainment Scale for Clinical Use. Per 25.....	1.00
	Per 100 .....	3.00
<p>In order to make careful differentiation of mentally handicapped children for special classes, it is necessary to secure information from the most important fields which bear on the causation and treatment of mental retardation. It has been found in practice that uniformity in the psycho-educational clinic cannot be secured without the use of various forms. During the last twenty years, Dr. J. E. W. Wallin has been using five simple forms which call for the essential information needed regarding the personal and family history of children examined, the school history, including educational attainment and character traits, and the results of a general physical and mental examination. These forms (Nos. 44044, 44044A, 44044B, 44044C, and 44044D) have been improved from time to time and have proved their value in practice. They antedate by several years the "Fields of Inquiry" later popularized by Dr. Walter Fernald.</p>		
44044.	<b>Report of Examination, Wallin's.</b> Per 25.....	.50
	Per 100 .....	1.50
44044A.	<b>Home Conditions and Personal and Family History, Wallin's.</b> Per 25.....	1.00
	Per 100 .....	3.00
44044B.	<b>Physical Examination of Pupil Recommended for Examination, Wallin's.</b> Per 25.....	1.00
	Per 100 .....	3.00
44044C.	<b>Educational Record, Wallin's.</b> Per 25.....	1.00
	Per 100 .....	3.00
44044D.	<b>Individual Mental Examination, Wallin's.</b> Per 25.....	1.25
	Per 100 .....	3.75
44070.	<b>Record Blanks.</b> For No. 32002 Phonograph Record. Per 100.....	2.25
44087.	<b>Record Blanks, Psychiatric, Schwartz's.</b> A referral blank for use in juvenile court clinics. Per 25 .....	1.00
	Per 100 .....	3.00
44090.	<b>Scoring Sheets, Analytical, Watson's.</b> For scoring the individual in the No. 24522 Public Opinion Test. Per 25.....	2.00
	Per 100 .....	6.00

### MODELS—CHARTS—LANTERN SLIDES— MOTION PICTURE FILMS

45058.	<b>Arterial Elasticity Model, Marey's.</b> A simple and compact device for demonstrating that an elastic tube delivers more fluid than a rigid tube. The apparatus consists of a Marriott's flask with a stop-cock terminating in a tube with a "Y" connection. One of the arms of the Y-tube leads to a rigid tube and the other to an elastic tube. A knife switch operating over the rubber connections between the Y-tube and the elastic and rigid tubes serves for instantly cutting off or releasing the flow of water from the Marriott flask. The two graduated cylinders serve to measure the amount of fluid passing within a definite period of time. (S.P.P.:295, 296, 298) .....	10.00
--------	------------------------------------------------------------------------------------------------------------------------------------------------------------------------------------------------------------------------------------------------------------------------------------------------------------------------------------------------------------------------------------------------------------------------------------------------------------------------------------------------------------------------------------------------------------------------------------------------------------------------------------------------------------------------------------------------	-------

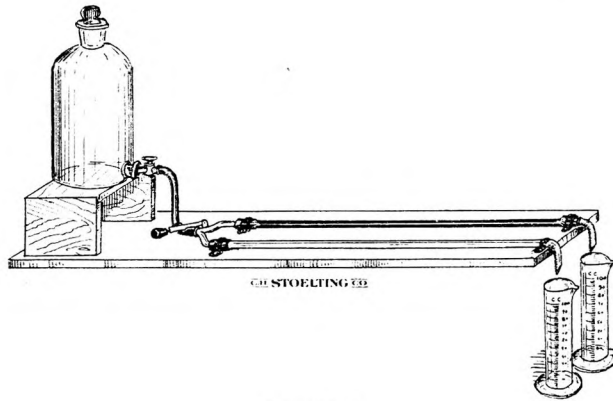

No. 45058.

Number		Price
45066.	Wire, Piano, No. 20, 1 M. length (50:X7).....	\$ .30

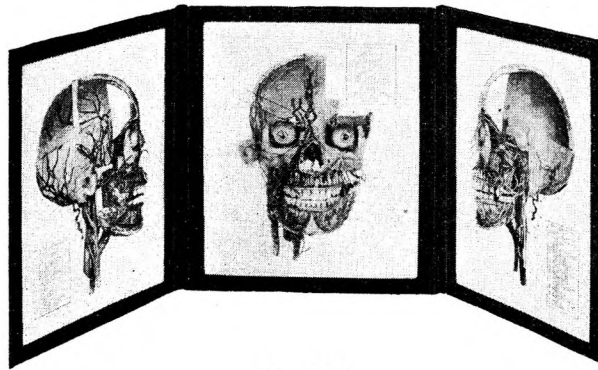

No. 45128.

45128.	<b>Head Charts.</b> Three life size portraits of a remarkable head anatomy by Tramond of Paris, France. These portraits show, with photographic accuracy, the entire network of nerves, blood vessels and muscles. The nerves and blood vessels are shown on separate portraits thereby forming individual statistics on these important points. Fifty-one distinct items are scientifically named and numerically indicated by pointers. Size of folder 10½x31 in.....	1.85
45150.	<b>Portraits.</b> These are additions to those listed on page 198 of the 1930 edition of our general catalog. *They are all photographs.  <div style="display: flex; justify-content: space-around; margin-top: 10px;"> <div style="text-align: left;">*Ebbinghaus, H. *Galton, F.</div> <div style="text-align: left;">*Koffka, K. *Köhler, W.</div> <div style="text-align: left;">*Pavlov, I. P. *Wertheimer, M.</div> </div>	1.25
45301B.	<b>Lantern Slides.</b> The "B" section of the No. 45301 Lantern Slides covering the human nervous system. 36 slides. (50:X20).....	28.80
45315.	<b>Lantern Slide, Maze Pattern, Ford's.</b> (50:X26).....	1.50
45316.	<b>Lantern Slides, Tachistoscopic, Ford's.</b> A set of sixteen. Eight of the lantern slides have an irregular arrangement of dots ranging from 3 to 10 dots on a slide, and eight of the lantern slides have an orderly arrangement of dots ranging from 9 to 100 dots each. Well adapted for experiments on the span of attention. (50:X30).....	12.80
45317.	<b>Lantern Slides, Ford's.</b> A set of twelve lantern slides of advertising headlines taken from magazine advertisements. The slides show variations from four words and up in the length of the line. (50:X44).....	9.60
45318.	<b>Lantern Slides, Kohler's Figures, 9a, 9b and 9c.</b> (50:X35).....	4.50
45319.	<b>Lantern Slide, Ford's.</b> Visual Contrast Effect. (50:X35).....	1.50
45320.	<b>Lantern Slide, Spectrum, Ford's.</b> Hand painted. (50:X10).....	5.60

Number		Price
45330.	<b>Lantern Slides, Metfessel's.</b> For Negative After-Image. A set of four, yellow, green, red and blue. (128:41; 128A).....	\$ 3.20
45331.	<b>Lantern Slide, After-Image.</b> General U. S. Grant's picture from the Farm Journal. (128:41; 128A) .....	.80
45335.	<b>Lantern Slides, Metfessel's.</b> For successive visual contrast. A set of four: yellow, green, red and blue. (128:44).....	3.20
45336.	<b>Lantern Slides, Metfessel's.</b> For simultaneous contrast. A set of two: red-green and yellow-blue. (128:44; 128A).....	1.60
45336A.	<b>Metal Screen.</b> For use with the No. 45336 Lantern Slide. (128:44; 128A).....	2.00

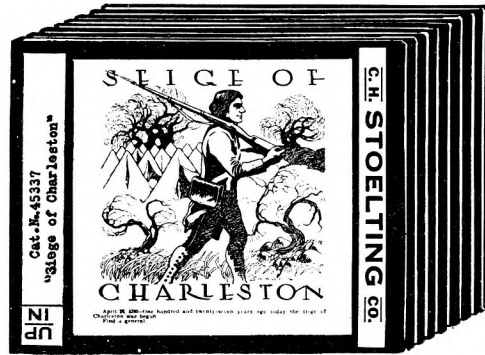

No. 45337

45337.	<b>Lantern Slides, Titchener's.</b> A set of eight taken from the No. 34005 Titchener Puzzle Pictures. Used to demonstrate that when the concealed figures are once found, they force themselves persistently upon the attention to such an extent that the "sense" of the picture recedes into the background. (128:67; 128A).....	6.40
45338.	<b>Lantern Slides, Illusion.</b> A set of sixteen slides taken from the No. 27000 set of Optical Illusions. (128:67, 105; 128A).....	12.80
45339.	<b>Lantern Slides, Metfessel's.</b> A set of three slides with stimulus words (128:76, 83; 128A).....	2.40
45340.	<b>Lantern Slides, Metfessel's.</b> A selection from the Hollingworth and Poffenberger set of No. 32135 photographs; memory for names and faces. Set of three, A, B and C. (128:95; 128A).....	2.40
45341.	<b>Lantern Slides, Metfessel's.</b> A set of three A, B and C, for comparison of recall and recognition. (128:99; 128A) .....	2.40
45342.	<b>Lantern Slide.</b> Rubin's "goblet." An ambiguous figure which makes an excellent slide for class demonstration of figure and ground reversal. (128:105; 128A).....	.80
45343.	<b>Lantern Slide, Herrick's.</b> After Dana and Starr. For illustrating referred pains and their causes (128:106; 128A; "Lancet," 1932:222, 337, 338).....	.80
45344.	<b>Lantern Slides.</b> Set of twelve from the No. 36244 Feleky photographs. (128:115; 128A).....	9.60
45345.	<b>Lantern Slide, Metfessel's.</b> Judging intelligence from photographs. (128:115; 128A).....	.80
45346.	<b>Lantern Slides.</b> Street's Gestalt Completion Tests. A set of thirteen. (128:117; 128A).....	10.40
45347.	<b>Lantern Slide, Metfessel's.</b> A picture for a class demonstration in problem-solving. (128:124; 128A) .....	.80
45348.	<b>Lantern Slide, Hill's</b> ambiguous figure. (128:105; 128A).....	.80
45349.	<b>Lantern Slide, Illusion, Schumann's;</b> Modified by Warren and Carmichael. (128:105; 128A)....	.80
45350.	<b>Lantern Slides, Carmichael and Roberts.</b> A set of 35 slides of the No. 36254 photographs, covering a study of emotional expression by means of the hands. (J.o.Ex.P., Aug. 1935:482-498)	28.00
45402.	<b>"The Pecking Instinct in Chicks,"</b> motion picture film, University of Michigan. A 16 mm. film. Length, approximately 118 ft.; time, approximately 5 min.; speed, standard 16 frames per sec. Compares normal chicks with experimental chicks. Experimental chicks placed in dark after hatching for 3, 7, 8 and 14 days, being hand-fed in total darkness. The picture shows the method of feeding and the behavior of pecking upon first exposure to daylight. If the film is stopped at critical positions, it is possible to make a quantitative statement of the effect of delay in the expression of the instinct. An exhibition of the method of Shepherd and Breed's original experiment cited in Watson's and Hunter's textbooks. The section of the film dealing with the eight-day delayed chicks is quite dense due to the conditions in which the pictures are made. All details are present in the film, however, and may be made visible to a class with a 250 watt projector used at a distance of about 20 feet from the screen in a well darkened room. (50:X9).....	8.35
45403.	<b>"Stimulation of Semicircular Canals,"</b> motion picture film, University of Michigan. A 16 mm. film. Length, approximately 34 ft.; time, approximately 1½ min.; speed, standard 16 frames per sec. The static sense. A qualitative demonstration exhibits the method of using the Barany Chair and the general disturbance of postural reflexes and errors of past-pointing. (50:X15; 102A:233-248) .....	2.80
45404.	<b>"Mechanics of the Brain,"</b> motion picture film, Pavlov's. A 35 mm. film. Length, approximately 6000 ft.; time, approximately 4 hrs.; speed, standard 16 frames per sec. From the Physiological Laboratory of the Russian Academy of Sciences. (50:X16).....	666.00

**N.B.** This motion picture film may be rented on the following basis: \$44.45 for an auditorium seating up to 300 and \$55.55 for an auditorium with a seating capacity of 300 to 500. The rental price does not include transportation.

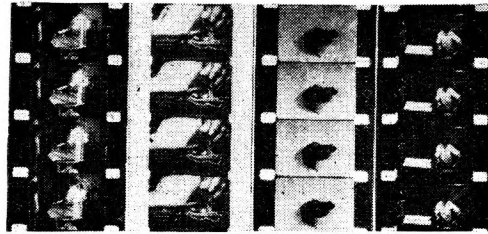

Nos. 45403-11-20-27.

Number		Price
45405.	<b>"Conditioned Responses,"</b> motion picture film, Ford's. A 16 mm. film. Length, approximately 250 ft.; time, approximately 10½ min.; speed, standard 16 frames per sec. An animal experiment. Demonstration of the simple reflexes in the decerebrate frog to show native responses. Phototropisms in water insects. A turtle learns a simple place association in a T-discrimination box. The entire history of the learning is given. The hooded rat on the elevated T-discrimination pathway learns to turn always toward a white light; another rat learns to turn away from a white light. The film ends with the suggestion that complex human skills are forms of conditioned responses. (50:X16).....	\$ 16.70
45406.	<b>"Reaction Time,"</b> motion picture film, Ford's. A 16 mm. film. Length, approximately 420 ft.; time, approximately 17½ min.; speed, standard 16 frames per sec. This is a very instructive film of the reaction time and comprises the following: I. Computation of the probable error in the Dunlap Chronoscope. II. Vocal responses to spoken words, using two Dunlap Voice Keys. III. Finger response time to spoken words. IV. Finger response time to the flash of a Neon light. V. Multiple choice response time in a five-way situation. Two subjects with 10 responses each. The film shows all computations. (50:X17).....	27.80
45407.	<b>"Reasoning,"</b> motion picture film, University of Michigan. A 16 mm. film. Length, approximately 400 ft.; time, approximately 16 2/3 min.; speed, standard 16 frames per sec. This film demonstrates reasoning in solving the T-Block Puzzle. (50:X18).....	33.35
45408.	<b>"Rote Learning,"</b> motion picture film, Ford's. A 16 mm. film. Length, approximately 51 ft.; time, approximately 2 min. (adequate for over an hour's experiment); speed, standard 16 frames per sec. This film is repeated over and over again in the process of learning. There are four sets of four nonsense syllables for an experiment on divided versus whole recitation, and lists of four, six, eight, and ten syllables for experiments on the relation of length of series to the number of repetitions required. The syllables are learned one at a time in serial order (not by the method of paired associates). While the class is attempting to reproduce each list, the operator turns the projector back to the beginning of the list preparatory for another exposure. The length of exposure time for each syllable is perfectly constant within the limits of speed variation in the projector motor. (50:X24).....	3.35
45409.	<b>"Maze Learning in the White Rat,"</b> motion picture film, University of Michigan. A 16 mm. film. Length, approximately 400 ft.; time, approximately 17 min.; speed, standard 16 frames per sec. The experiments shown in this film were performed by Dr. Norman F. Maier in the Psychological Institute of the University of Berlin, Dr. Wolfgang Köhler, Director. This film shows the entire learning history of the white rat in the process of learning a maze containing seven blinds of both the circular and the "cul-de-sac" type. It also shows the effect of changing one pathway in a maze previously well learned. It is possible to construct curves of error or of time, giving something of a quantitative statement of the laws of learning. Photography of this film is very good and it was taken under thoroughly controlled laboratory conditions. Experienced rats; mercury-vapor illumination. Contains a demonstration of the maze construction. (50:X27; 128:75).....	26.70
45410.	<b>"Illusions of Movement,"</b> motion picture film, Ford's. A 16 mm. film. Length, approximately 50 ft.; time, approximately 2 min.; speed, standard 16 frames per sec. Since the operator should stop after each section to allow introspective reports written on note paper, the actual time required for a demonstration will be approximately half an hour. The film reproduces some of the effects of the Phi Phenomenon of Wertheimer. Dr. Sugi Mibai's black bar is seen to move laterally and rotationally, although it has merely appeared in one place and then in another, divided by a period of perfectly blank screen. It also shows a phi phenomenon as presented in the flashing lights of Miles'. (50:X35).....	3.35
45411.	<b>"Motor Aptitude,"</b> motion picture film, Ford's. A 16 mm. film. Length, approximately 216 ft.; time, approximately 9 min.; speed, standard 16 frames per sec. A demonstration of the technique of administering simple tests having a bearing on mechanical aptitude. It shows the Whipple test, the slot-board test, the bolt assembly test in two forms, the match-board test, stylus tapping test, and test of dimension perception with competitive pairs of subjects working side by side. (50:X38).....	13.35
45412.	<b>"Behavior of the Feeble-minded,"</b> motion picture film, University of Michigan. A 16 mm. film. Length, approximately 267 ft.; time, approximately 11½ min.; speed, standard 16 frames per sec. This film exhibits four institutional cases on the Healy and Fernald test for assembly or blocks. Two normal fourteen-year-old boys show a test time of 8 to 9 seconds. These are compared with a twenty-four-year-old feeble-minded woman and a low-grade moron boy of fourteen years. Taken in the Wayne County Training School under the direction of Dr. Thorlief Hegge. Good photography, with close-up of pictures. Time measurements exhibited. (50:X42).....	24.00

Number		Price
45413.	<b>"Industrial Motion Analysis,"</b> motion picture film, Ford's. A 16 mm. film. Length, approximately 264 ft.; time, approximately 11 $\frac{1}{8}$ min.; speed, standard 16 frames per sec. This film illustrates six occupations in a silk garment factory. Each scene is timed and includes a Whipple stop-clock in the illustration. The ironing operation is broken into "therblics" or movement analysis, using animated diagrams. This film may be used for a group experiment on the Gilbreth methods. (50:X43).....	\$ 16.65
45414.	<b>"The Nerve Impulse,"</b> motion picture film, Ford's. A 16 mm. film. Length, approximately 210 ft.; time, approximately 9 min.; speed, standard 16 frames per second. Animated diagrams illustrating discoveries of Lucas, Adrian, Forbes, Lillio and others. A demonstration of the "steel nerve" .....	13.40
45415.	<b>"Tachisfoscopic Perception,"</b> motion picture film, Ford's. A 16 mm. film. Length, approximately 100 ft.; time, approximately 4 min.; speed, standard 16 frames per second. This film presents stimulus patterns for 72 responses in a group experiment. I. Span of Attention for Nonsense Item; II. The Span of Attention for Orderly Arrays; III. Perception Supplementation; IV. The Influence of Mental Set.....	6.70
45416.	<b>"Dynamic Manual Expression,"</b> motion picture film, Wessell and Carmichael. A 16 mm. film. Length, approximately 261 ft.; time, approximately 10 $\frac{7}{8}$ min.; speed, standard 16 frames per sec. The film shows a series of twenty dynamic expressions, acted out by an experienced actor (Thomas Crosby, Jr.), who attempted to represent various emotional states by means of the hands and arms alone. These isolated patterns of human response were judged by 292 adults as to the emotional or other states being portrayed. The gestures, then, are given two titles, (1) that which was intended by the actor, (2) that which was judged by the subjects. Each expression is repeated three times, starting in every case from a neutral position. A common ability of judgment was found in some ways as satisfactory as the commonality found in judgments of facial expression. The dynamic gestures giving the highest commonality were judged as follows: (1) Prayer, (2) Pleading, (3) Fear, (4) Determination, (5) Anxiety, (6) Warning, (7) Pleading, (8) Satisfaction, (9) Determination, (10) Satisfaction.....	23.50
45420.	<b>"Reflexes in the Frog,"</b> motion picture film, Metfessel and Musgrave. A 16 mm. film from the University of Southern California. Length, approximately 212 ft.; time, approximately 11 $\frac{3}{4}$ min.; speed, 12 frames per sec. There are three parts to this film: (A) Righting reactions of normal, partially pithed, and completely pithed frog; (b) Frogs with varying degrees of brain tissue removed tested for swimming reactions; (c) Experiments—chemical and electrical—on the decerebrated and pithed frogs shown side by side. (128:53; 128A).....	19.70
45421.	<b>"Determiners of Attention,"</b> motion picture film, Metfessel and Musgrave. A 16 mm. film from the University of Southern California. Length, approximately 76 ft.; time, approximately 4 $\frac{1}{4}$ min.; speed, 12 frames per sec. This film supplies a practice trial and 25 sets or trials in which the students are required to record each attracting object by position number. Trials 2, 6, 11, 18 and 25 have the letter "O" tinted red in order to agree with the instructions in the "Student's Guide" for which it was designed. (128:68; 128A).....	7.25
45423.	<b>"Range of Visual Perception,"</b> motion picture film, Metfessel and Musgrave. A 16 mm. film from the University of Southern California. Length, approximately 50 ft.; time, approximately 2 $\frac{3}{4}$ min.; speed, 12 frames per sec. This film supplies a practice trial and 16 tests or trials of ten-letter series, in which the students are required to record in order all the letters seen in each glimpse. (128:69; 128A).....	4.25
45424.	<b>"Reliability of Memory,"</b> motion picture film, Metfessel and Musgrave. A 16 mm. film from the University of Southern California. Length, approximately 40 ft.; time, approximately 1 $\frac{2}{3}$ min.; speed, standard 16 frames per sec. This film shows a scene of interest-arresting activity and gives the students four trials or tests for reporting all the incidents they are able to remember. (128:99, 151; 128A).....	3.45
45425.	<b>"Measurement of the Müller-Lyer Illusion,"</b> motion picture film, Metfessel and Musgrave. A 16 mm. film from the University of Southern California. Length, approximately 47 ft.; time, approximately 2 $\frac{1}{2}$ min.; speed, 12 frames per sec. The film provides 11 preliminary trials for the estimation of length, followed by six trials or test series of 11 numbered views. The students are asked to report the number when the two distances are equal. (128:106; 128A).....	4.00
45426.	<b>"Types of Apparent Movement,"</b> motion picture film, Metfessel and Musgrave. A 16 mm. film from the University of Southern California. Length, approximately 241 ft.; time, approximately 13 $\frac{1}{3}$ min.; speed, 12 frames per sec. The film provides preliminary trials for students' observation and a series of views covering (A) time and distance as determiners of the Phi Phenomenon; (B) eye movements and the Phi Phenomenon; (C) movement in the third dimension—1, Beta movement; 2, Phi Phenomenon with interposed stimulus; 3, modifications of Steinig's figures; (D) Wertheimer's test. The students are required to record their impressions. (128:11; 128A) .....	22.20
45427.	<b>"The Development of Behavior in the Fetal Cat,"</b> motion picture film, Coronius, Schlosberg, and Carmichael. A 16 mm. film from Brown University. Length, approximately 380 ft.; time, approximately 15 $\frac{3}{4}$ min.; speed, standard 16 frames per sec. A manual and two developmental charts are included with each film. This film forms only a part of an experimental study of the development of behavior in the fetal cat. The two developmental charts which accompany the manual and the final conclusions of the experiment were based not only on the results of the motion picture records but in large part on a great number of written protocols secured during the course of this experimental study. In order to be able to observe the fetal material under approximately normal conditions with the umbilical circulation intact, a bath apparatus was devised to insure controlled temperature and other necessary conditions for the successful photography of this difficult subject. (G.P.M., Oct. 1933).....	34.30
45429.	<b>"The Ape and The Child,"</b> motion picture film, W. N. and L. A. Kellogg. A 16 mm. film from the University of Indiana. Four reels of approximately 400, 372, 378, and 340 ft.; time, approximately 16 $\frac{2}{3}$ , 15 $\frac{1}{2}$ , 15 $\frac{3}{4}$ and 14 $\frac{1}{8}$ min., respectively; speed, standard 16 frames per sec. A mimeographed description of 3 pages accompanies each set of films. A full account of all the behaviors shown in the film can be obtained from the book. Reel No. 1, "Some Behavior Characteristics of a Human and a Chimpanzee Infant in the Same Environment," traces the general behavior of a normal human subject between the	



Number		Price
	<p>ages of 10 and 14.5 months as he develops in typical civilized surroundings. The accomplishments of the child are compared step by step with the analogous behavior of his chimpanzee companion who is reared with him in the same environment. The age of the animal within the time covered by the film ranges between 7.5 and 12 months. Reel No. 2, "Comparative Tests on a Human and a Chimpanzee Infant of Approximately the Same Age," demonstrates the reactions of a normal infant age 10 to 14.5 months in a series of simple psychological tests. The responses of a chimpanzee infant age 7.5 to 12 months in the same tests are compared with those of the child. Reel No. 3, "Experiments Upon a Human and a Chimpanzee Infant After Six Months in the Same Environment," demonstrates some of the more complex tests and experiments. Reel No. 4, "Some General Reactions of a Human and a Chimpanzee Infant After Six Months in the Same Environment," compares the non-experimental behavior of an infant chimpanzee to that of a normal human infant reared with the animal in the same environment. The pictures encompass an age range of 13.5 to 16.5 months for the chimpanzee and 16 to 19 months for the child.</p> <p>Reels 1 and 2 give a record of the development of the ape and the child during the first half of the nine months' investigation.</p> <p>Reels 2 and 3 demonstrate thirteen of the tests and experiments to which the subjects were submitted during the entire period of comparison.</p> <p>Reels 3 and 4 record the experimental and non-experimental behavior during the last part of the investigation.</p> <p>Reels 1 and 4 illustrate the development of incidental behavior traits throughout the whole period of the investigation. (107A).</p> <p>Prices: Reel No. 1, \$36.20; Reel No. 2, \$33.60; Reel No. 3, \$34.20; Reel No. 4, \$31.00. Complete set of four reels.....</p>	<p><b>\$135.00</b></p>
45431.	<p>"<b>Experimental Investigation of Babies,</b>" motion picture film, Watson's. A 34 mm. film from Johns Hopkins University. Length, approximately 1200 ft.; time approximately 21 min.; speed, standard 16 frames per sec. This is a 2 reel film. After our stock of this film is exhausted, it will be carried in the 16 mm. size only.....</p>	<p><b>83.35</b></p>
45431A.	<p>"<b>Experimental Investigation of Babies,</b>" motion picture film, Watson's. A 16 mm. film from Johns Hopkins University. Length, approximately 500 ft.; time, approximately 21 min.; speed, standard 16 frames per sec.....</p>	<p><b>45.00</b></p>
45433.	<p>"<b>The Phi-Phenomenon,</b>" motion picture film, Ruckmick and Greenwald. A 16 mm. film from the State University of Iowa. Length, approximately 230 ft.; time, approximately 8½ to 9½ min.; speed, 16-18 frames per sec. This film shows four different phases of the perception of movement. The introductory views show common perceptions of movement in every-day life: the movements of lights at the entrances of motion picture theaters, the rotation of automobile wheels, the passing of scenery as seen from a car. The main portion of the film illustrates various phases of alpha, beta, gamma and delta type of movement. The film is fully titled and competently timed to be run at the speeds referred to above. Some of the more complicated movements, such as movements in several directions at the same time, are given at the end .....</p>	<p><b>20.70</b></p>
45435.	<p>"<b>Motor Conditioning in Dogs,</b>" motion picture film, Culler's. A 16 mm. film from the University of Illinois. Length, approximately 189 ft.; time, approximately 7¾ min.; speed, 16 frames per sec. This film shows a carefully standardized method of motor conditioning in dogs. The animal responds in the usual way by withdrawing the foot from a metal grid when the substitute stimulus (tone) is applied. It differs, however, from the usual films on conditioning by emphasizing the quantitative aspects of the method. Conditioned behavior sometimes gives the impression of a "stunt" which the animal is taught to perform; the result is more interesting than useful. Here, on the contrary, is clearly shown how the sensory acuity of an animal may be measured with great precision and how the method may be applied to various scientific problems. Particular care was used in securing a good, well-focused negative.....</p>	<p><b>17.00</b></p>
45436.	<p>"<b>Views of a Decorticate Dog,</b>" motion picture film, Culler's. A 16 mm. film from the University of Illinois. Length, approximately 207 ft.; time, approximately 8 3/5 min.; speed, 16 frames per sec. This film gives direct visual acquaintance with a completely decorticate dog. Ablation of cortex was effected in four stages extending over a period of six months, the film being taken about two months after the final entry. Included are scenes showing the animal's distinctive postures when standing or recumbent; his mode of locomotion, his behavior under difficulties, his ways of eating, his abnormally dilated pupils, his resistance to impressed movements, and his rage under slight stimulation. Of special interest for many persons should be the clear demonstration of conditioning to a loud tone. To psychologists, physiologists and neurologists, in particular to the many who have never had opportunity to see a decorticate dog, the film should be of definite value.....</p>	<p><b>18.70</b></p>
45438.	<p>"<b>Human Vocal Cords in Action,</b>" motion picture film, Tiffin's. A 16 mm. film from the Iowa Laboratories of Experimental Phonetics. Length, approximately 140 ft.; time, approximately 7 min.; speed, 16 frames per sec. This film gives the student of speech and voice a clear idea of the nature and functioning of the vocal cords. It shows the vocal cords from several distances, their functioning during breathing and phonation, the adjacent organs including the arytenoids and epiglottis, and several remarkable views of the cords in slow motion taken with stroboscopic illumination and a magnifying lens. The latter views show each vibration slowed down to several seconds duration.....</p>	<p><b>18.40</b></p>

## KEY TO ABBREVIATIONS

American Journal of Insanity .....	A.J.o.I.
American Journal of Ortho-Psychiatry .....	A.J.o.O.
American Journal of Physiology .....	A.J.o.Py.
American Journal of Physiological Optics.....	A.J.o.P.O.
American Journal of Psychiatry .....	A.J.o.Ps.
American Journal of Psychology .....	A.J.o.P.
American Journal of Sociology .....	A.J.o.S.
Archives of Neurology and Psychiatry .....	A.o.N.a.Ps.
Archives of Psychology .....	Ar.o.P.
British Journal of Psychology .....	B.J.o.P.
British Journal of Psychology Monographs .....	B.J.o.P.M.
Chicago Child Study Reports.....	C.C.S.R.
Columbia Contributions to Education .....	C.C.t.E.
Columbia Contributions to Philosophy and Psychology.....	C.C.t.P.a.Ps.
Comparative Psychology Monographs.....	C.P.M.
Dental Cosmos .....	D.C.
Educational Administration and Supervision.....	E.A.a.S.
General Electric Review .....	G.E.R.
Genetic Psychology Monographs .....	G.P.M.
Harvard Monographs in Education.....	H.M.i.E.
Industrial Psychology .....	I.P.
Institute of Child Welfare Monographs.....	I.o.C.W.M.
Journal of Abnormal and Social Psychology.....	J.o.A.a.S.P.
Journal of Applied Psychology .....	J.o.A.P.
Journal of Comparative Psychology .....	J.o.C.P.
Journal of Delinquency .....	J.o.D.
Journal of Educational Psychology .....	J.o.E.P.
Journal of Educational Research .....	J.o.E.R.
Journal of Experimental Pedagogy .....	J.o.E.Ped.
Journal of Experimental Psychology .....	J.o.Ex.P.
Journal of General Psychology .....	J.o.G.P.
Journal of Genetic Psychology .....	J.o.G'c.P.
Journal of National Institute of Industrial Psychology.....	J.o.N.I.I.P.
Journal of Nervous and Mental Disease.....	J.o.N.a.M.D.
Journal of Personnel Research .....	J.o.P.R.
Journal of Psycho-Aesthetics .....	J.o.P.A.
Journal of Social Psychology .....	J.o.S.P.
Pedagogical Seminary .....	P.S.
Pedagogical Seminary and Journal of Genetic Psychology.....	P.S.a.J.o.G.P.
Police 13-13 .....	P.
Psyche .....	Psy.
Psychobiology .....	Ps'b.
Psychological Bulletin .....	P.B.
Psychological Clinic .....	P.C.
Psychological Monographs .....	P.M.
Psychological Review .....	P.R.
School and Society .....	S.a.S.
School Review .....	S.R.
School Science and Mathematics .....	S.S.a.M.
Science .....	S.
Social Science Monograph .....	S.S.M.
Teachers' College Record.....	T.C.R.
The Human Factor .....	H.F.
The Personnel Journal .....	P.J.
Training School Bulletin .....	T.S.B.
United States Public Health Service Bulletin.....	U.S.P.H.S.
University of Iowa Studies in Psychology.....	U.o.I.S.i.P.
Vocational Guidance Magazine .....	V.G.M.
Chapter .....	C.
Demonstration .....	D.
Experiment or Exercise .....	X.
Lesson .....	L.
Study .....	S.
Test .....	T.

References in parentheses follow the majority of catalog descriptions. At the left of the colon are given the abbreviations of the publications in the preceding list, or their reference numbers or letters in the list following. The figures at the right, unless preceded by a letter, indicate pages. As an accommodation, we carry a small supply of all the publications priced. Those unpriced (O.o.P.) are out of print, or in a few cases (H.b.P.), handled exclusively by the publisher. The names of textbooks and manuals for physiology and pharmacology, like the periodicals, are indicated by letters. We have continued the innovation of giving references, and would suggest that you consult pages 202-207 of the first, second and third editions of the 1930 catalog, in the event that you fail to find the publication on pages 56-57 of this catalog.

## BOOKS—PERIODICALS—REPRINTS

Ref. No.	Cat. No.	(Psychology)	Price
(5A)	46079A.	"A Point Scale of Performance Tests: Clinical Manual," G. Arthur. Vol. I.....	\$ 1.70
(5B)	46079B.	"A Point Scale of Performance Tests: The Process of Standardization," G. Arthur. Vol. II .....	1.70
(10)	46083A.	"Measurement of Mental Deterioration," H. Babcock. Ar.o.P. No. 117.....	1.40
(11A)	46084C.	"Aviation Medicine," L. H. Bauer.....	8.35
(11B)	46086A.	"Aptitudes and Aptitude Testing," W. V. Bingham.....	3.35
(12)	46089.	"Intelligence, Its Manifestations and Measurement," P. L. Boynton.....	2.80
(12A)	46085A.	"The Rorschach Test as Applied to a Feeble-minded Group," S. J. Beck. Ar.o.P. No. 136, May, 1932 .....	1.15
(12B)	46085B.	"General Experimental Psychology," A. G. Bills.....	4.45
(16)	46092.	"Psychology," E. G. Boring, H. S. Langfeld and H. P. Weld.....	3.10
(24)	46119.	"Common Annoyances: A Psychological Study of Everyday Aversions and Irritations," H. Cason. P.M., Vol. XL, No. 182, 1930.....	3.70
(24A)	46114.	"The Estimation of Juvenile Incurrigibility," V. M. Cady. J.o.D.Mon., Apr. 1923....	2.40
(25A)	46121.	"Color Blindness: Its Relation, Etc.," G. L. Collins. U.S.P.H.S., P.H.B. 92, 1918....	.35
(26)	46121A.	"Colour Blindness," M. Collins.....	2.50
(30)	46131.	"A Performance Ability Scale," E. L. Cornell and W. W. Coxe.....	1.70
(31A)	46127.	"A Syllabus for the First Course in Experimental Psychology," S. L. Crawley.....	1.35
(31B)	46126.	"A Measure of Manual Ability," A. C. Crockett. J.o.A.P., Vol. 14, No. 5, Oct. 1930....	.50
(32A)	46129A.	"An Experimental Manual in Psychology," J. F. Dashiell.....	2.15
(32D)	46139.	"General Psychology," F. C. Dockeray.....	3.35
(50)	46155.	"Group Experiments in Elementary Psychology—Students' Manual and Notebook," A. Ford .....	1.40
(56)	46170A.	"Nervous and Mental Re-education," S. I. Franz.....	3.05
(58)	46172.	"Psychology," S. I. Franz and K. Gordon.....	2.80
(58A)	46173.	"Psychology Work Book," S. I. Franz and K. Gordon.....	1.40
(61A)	46194.	"Measurement of Interests," D. Fryer.....	5.00
(62)	46204.	"Great Experiments in Psychology," H. E. Garrett.....	2.80
(62A)	46204A.	"Psychological Tests: Methods and Results," H. E. Garrett and M. R. Schneck....	3.05
(67A)	46208A.	"Infant Behavior—Its Genesis and Growth," A. Gesell and H. Thompson.....	3.35
(68)	46209.	"Infancy and Human Growth," A. Gesell.....	3.90
(70)	46215.	"Psychology of Human Behavior," J. H. Griffiths.....	2.80
(72)	46216.	"Developmental Psychology," F. L. Goodenough.....	3.35
(78)	46232.	"Laboratory Studies in Psychology," J. P. Guilford.....	1.55
(86)	46260.	"Psychological Service for School Problems," G. H. Hildreth.....	2.40
(86A)	46261.	"A Bibliography of Mental Tests and Rating Scales," G. H. Hildreth.....	3.35
(163A)	46491A.	"Manual of Directions: P&P Short Performance Tests," G. H. Hildreth and R. Pintner .....	.55
(100)	46378A.	"The Kohs' Block Design Test—A Revision for Clinical Practice," M. L. Hutt. Reprint from the J.o.A.P., Vol. XVI, No. 3, June 1932, pp. 298-307.....	.40
(102)	46308.	"Colour Blindness—Its Dangers and Its Detection," B. J. Jeffries.....	O.o.P.
(102A)	46307.	"Equilibrium and Vertigo," I. H. Jones (1923 Ed.).....	6.70
(107A)	46345.	"The Ape and the Child," W. N. and L. A. Kellogg.....	3.35
(110)	46325.	"Students' Attitudes—A Report of the Syracuse University Reaction Study," D. Katz and F. H. Allport.....	3.35
(120)	46392.	"Lying and Its Detection," J. A. Larson.....	5.55
(122)	46411.	"Visual Illusions and Their Applications," M. Luckiesh.....	O.o.P.
(122A)	46409.	"The Nature of Human Conflicts," A. R. Luria.....	4.45
(126)	46419.	"A Scale for Measuring Social Adequacy," M. J. McCormick. S.S.M., Vol. I, No. 3, Oct. 15, 1930.....	1.00
(128)	46420.	"Student's Guide for Demonstrations of Psychological Experiments," M. Metfessel .....	1.15
(128A)	46421.	"Instructor's Guide for Demonstrations of Psychological Experiments," M. Metfessel .....	1.15
(128R)	46420R.	"Student's Guide for Demonstrations of Psychological Experiments," M. Metfessel, et al. (Rev. Ed. 1936).....	1.65
(133)	46440A.	"Methods for Diagnosing and Treatment of Reading Disabilities," M. Monroe. G.P.M., Vol. 4, Nos. 4 and 5, Oct.-Nov. 1928.....	3.75
(133A)	46440B.	"Children Who Cannot Read," M. Monroe.....	2.80
(134A)	46441.	"Studies in Appreciation of Art," University of Oregon Monograph, Vol. 4, No. 6, Feb. 1934 .....	.75
(136E)	46444E.	"Experimental Social Psychology," G. and L. B. Murphy.....	3.90
(136F)	46444F.	"General Psychology," G. Murphy.....	3.90
(150)	46465.	"Born That Way," J. O'Connor.....	6.70
(150A)	46465A.	"Psychometrics," J. O'Connor .....	3.90
(154)	46477.	"Minnesota Mechanical Ability Tests," D. G. Paterson, R. M. Elliott, L. D. Anderson, H. A. Toops and E. Heidebreder.....	5.60
(158)	46486.	"The Selection of Color Workers," W. O'D. Pierce, et al.....	2.25
(158A)	46486A.	"Individual Differences in Normal Color Vision," W. O'D. Pierce.....	.90

BOOKS—PERIODICALS—REPRINTS—Continued

(Psychology)

Table listing psychology books with columns for Ref. No., Cat. No., Title, and Price. Includes titles like 'Intelligence Testing—Methods and Results', 'The Maze Test and Mental Problems', etc.

(Physiology)

Table listing physiology books, including 'Experimental Physiology' by E. Sharpey-Schafer (5th Ed.) with price 2.45.

Diagram of musical scales and intervals. Includes 'RATIO', 'INTERVAL', 'DIATONIC PHYSICAL SCALE', 'INTERNATIONAL TEMPERED SCALE', and musical staves for Bass and Treble clefs with notes and solfège syllables.

**SUPPORTS**

Number		Price
54024.	<b>Support.</b> This is a support with fine adjustment composed of the No. 22224A Support Rod with fine adjustment devised for use on our No. 22207 Kymograph mounted on a tripod base with two levelling screws. This support takes the place of the No. 54023 which has been discontinued .....	\$ 24.00

**CIRCULATION**

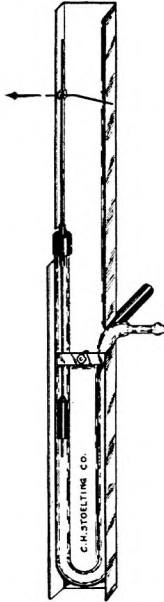

No. 56216.

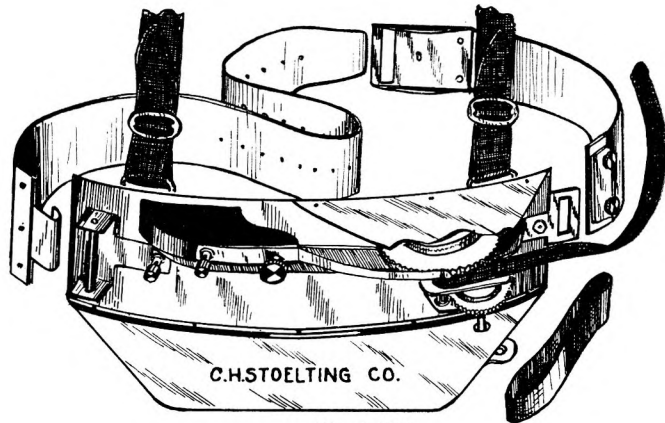

No. 57130.

56216.	<b>Manometer, Mercury, Camp's (W. J. R.).</b> Devised to eliminate the objectionable features of the usual simple form of manometer. The float or piston is unusually long and carefully fitted to the distal limb of the manometer in order to prevent its being immersed by a momentarily strong pressure in the proximal limb. An especially constructed cap extending well down the outside of the proximal limb is provided with a long guide tube for taking the guide rod projecting from the top of the float. This guide rod is made of very stiff wire and also acts as a stylus support. With this arrangement a perfect, frictionless alignment is maintained. As an additional precaution, the concave lower surface of the float is provided with a drag wire which dips well down into the mercury. The stylus is attached to the guide rod at right angles by means of an especially constructed light clip. This clip is so devised that the stylus will invariably maintain its position on the guide rod. The aluminum back of the manometer extends above the point at which the stylus is usually attached and by means of the turned-over ends of the back, it is possible to keep the stylus against the kymograph drum without resorting to strings, weights, or similar devices. To provide ready means for moving the manometer to and from the drum, we would suggest the addition of either the No. 22164 or No. 22166 Fine Adjustment Clamp. Manometer only.....	18.00
56467.	<b>Plethysmograph, Finger, Porter's.</b> This is a glass tube, one end of which is supplied with a rubber finger piece for making an air-tight connection with the middle finger and the other end is tapered off to take the rubber connecting tube of the recording tambour. (50:X41; P.P.:280, 281) .....	.50

**RESPIRATION**

57113.	<b>Pneumograph, Gutzmann and Scripture.</b> A distended soft rubber tube, 24 in. long, closed at both ends and attached to a wide cloth tape provided with a buckle. The closed rubber tube has a tambour connection projecting about 6 in. through the cloth tape for making connection by means of rubber tubing with the recording tambour. This pneumograph has the advantage that there is no metal coming in contact with the skin and that an inspiration moves the tambour stylus upward while expiration moves it downward. This is the opposite effect of the No. 53111 Sumner Pneumograph. (193).....	6.00
57130.	<b>Breathing Apparatus, Cason's.</b> This piece of apparatus gives an accurate record of the change in the circumference of the subject's body in the general region of the epigastrium or in any other region. In many pneumographs there is a certain leakage of air and the movement of the recording record is not directly proportionate to the amount of movement to the subject's body on account of the change in the tension of the rubber covering of the tambour. It is also not proportional to the amount of movement at the subject's end on account of the compression of air, etc. This piece of apparatus gives a record at any distance from the subject.	

Number		Price
	Some of the experiments were carried on with a distance of 40 ft. between experimenter and subject. The apparatus can be used in any experiment where a record is being made of breathing, either in psychology or in physiology. It also has a certain amount of use in ordinary studies of emotions, reflexes, movements, etc. (J.o.G.P., July 1933, No. 8; J.o.A.a.S.P., July 1933, No. 17; J.o.Ex.P., Jan. 1934, No. 17).....	\$ 75.00

### ELECTRICAL STIMULATION

58414.	<b>Pole Changer or Commutator.</b> A well-made D.P.D.T. switch with X connections, and mounted on a substantial wood base.....	1.50
--------	--------------------------------------------------------------------------------------------------------------------------------	------

### MUSCLES AND NERVES

59403.	<b>Muscle Warmer, Porter's.</b> Improved model as described in the American Journal of Physiology, 1904, x, p. viiii.....	6.00
--------	---------------------------------------------------------------------------------------------------------------------------	------

### PHONETICS

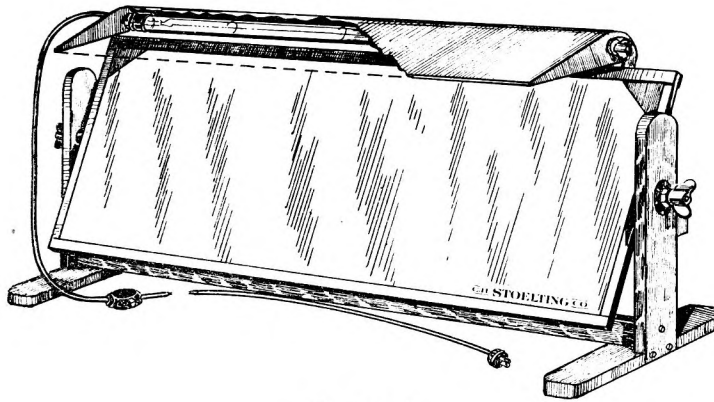

No. 69017.

69017.	<b>Ororeflector, Young's (H. H.).</b> This apparatus is designed to assist in the teaching of speech to children and adults. It consists of such an arrangement of a mirror and an electric light that two people seated in front of it can each see the reflection of the lower half of their faces at the same time, while the eyes of both are in darkness. If the mouth is opened, the entire oral cavity is flooded with light and is reflected in the mirror. This makes it possible to observe and study the size, shape, position, and movements of the lips, jaws, teeth, tongue, soft palate, uvula, and entire mouth in a bright light and to do so with ease because there is no direct light shining into the eyes. Both the light and the mirror can be easily adjusted to suit the convenience of people of different heights. (56:195, 196).....	45.00
--------	------------------------------------------------------------------------------------------------------------------------------------------------------------------------------------------------------------------------------------------------------------------------------------------------------------------------------------------------------------------------------------------------------------------------------------------------------------------------------------------------------------------------------------------------------------------------------------------------------------------------------------------------------------------------------------------------------------------------------------------------------------------------------------------------------------------------------------------------------------------	-------

### PHYSIOLOGICAL MODELS

73151.	<b>Circulation Apparatus, Porter's. New Model.</b> A demonstration device for illustrating the action of the heart and the circulatory system. This is a thoroughly well-made piece of apparatus intended not alone for demonstration purposes, but for individual study by the student. (P.P.:239-251) .....	18.75
73155.	<b>Respiration Apparatus, Porter's. New Model.</b> A piece of apparatus somewhat on the same order as the blood circulation apparatus used for class room demonstration, also for individual study by the student. Thoroughly well-made and very instructive. (A.J.o.P'y., 1904, x, p. xliii)	9.50

## AUTHORS' AND DESIGNERS' INDEX

Acting on the suggestions of a number of our friends, we have added this index of authors and designers, and hope it will provide additional assistance in locating apparatus, tests, questionnaires, record blanks, charts, lantern slides, and motion picture films in both the main catalog and this supplement. The page numbers preceded by the letter "S", refer to the pages of this supplementary catalog while the other numbers refer to the pages of the 1930 and subsequent editions of the main catalog.

## A

- Alexander's Manual .....S, 39  
 Alexander's Passalong Test.....S, 39  
 Alexander's Record Blanks.....S, 39, 48  
 Allport's Key .....119  
 Allport's Measurement of Students' Attitudes.....119  
 Allport's N.C. Rating Scale.....119  
 Allport's Social Relationship Questionnaire.....119  
 Allport's Systematic Questionnaires.....119  
 Allport and Langfeld Tachistoscope.....119  
 Almack's Scoring Blank.....163, 190  
 A. O. Co. Metron-O-Scopes .....S, 17, 18  
 A. O. Co. Ophthalm-O-Graphs .....S, 18  
 A. O. Co. C-I Ophthalmometer.....S, 2  
 A. O. Co. Perimeter .....S, 6  
 Amkino Corp. Motion Picture Film.....S, 51  
 Appun's Lamella .....31  
 Appun's Tonometers .....33, 34  
 Arthur's Modified Seguin-Goddard Form Board S, 35  
 Arthur's Performance Scales.....173, S, 41  
 Arthur's Scoring Cards.....S, 48  
 Atkins' Object-Fitting Test.....175, 176  
 Atkins' Record Blanks .....S, 48  
 Aubert's Diaphragm .....91  
 Aubert's Episcotisters .....25  
 Averill's Association Tests.....136, 137  
 Averill's Card Scoring Test.....144  
 Averill's Digit-Symbol Test.....139  
 Averill's Learning Tests.....141  
 Averill's Meaningful Words.....141  
 Averill's Memory Test.....152  
 Averill's Monosyllabic Word Lists.....141  
 Averill's Nonsense Syllables.....141, 152  
 Averill's Perception Test.....132  
 Averill's Rote Memory Test.....152  
 Averill's Sorting Test.....144  
 Averill and Mueller Achievement Test in  
 Psychology .....179  
 Averill and Mueller Manual .....179  
 Ayres Handwriting Scale.....178  
 Ayrton Adjustable Shunt.....116

## B

- Babcock's Mental Deterioration Test.....S, 41  
 Babcock's Record Blanks.....S, 41, 49  
 Baker's Visual Acuity Test.....S, 1, 2  
 Baldwin's Infant Stadiometer.....4  
 Baldwin and Stecher Association Test.....137, 138  
 Baldwin and Stecher Clapping Blocks.....90  
 Baldwin and Stecher Copying Test.....154  
 Baldwin and Stecher Design Test.....154  
 Baldwin and Stecher Dressing Frames.....62  
 Baldwin and Stecher Fraction Test.....179  
 Baldwin and Stecher Kindergarten Beads.....154  
 Baldwin and Stecher Number Concept Test.....179  
 Baldwin and Stecher Picture Memory Test.....153  
 Baldwin and Stecher Picture Vocabulary Scale.....178  
 Baldwin and Stecher Preschool Child Tests.....S, 41  
 Baldwin and Stecher Slotted Punch.....62  
 Baldwin and Stecher Sorting Boxes.....17  
 Baldwin and Stecher Sorting Tests.....62, 163  
 Baldwin and Stecher Stadiometer .....4  
 Baldwin and Stecher Tray .....57  
 Baldwin and Stecher Wood Frames .....62  
 Banister's Dart Test.....S, 13  
 Barany's Chairs .....S, 14  
 Barany's Noise Apparatus.....S, 14  
 Barlow's Tables .....1  
 Barrow's Tambour .....99  
 Basch's Time Marker.....68  
 Batson's Phonograph Interrupter.....89  
 Bayley's California First-Year Mental Scale S, 40, 41  
 Bayley's Record Blanks.....S, 41, 49  
 Bayley's Visual Memory Test.....S, 37  
 Beall and Hall Ataxiagraph.....67  
 Bengé's Clerical Test K.....182  
 Bengé's Instructions and Tables.....182  
 Bengé's Scoring Stencils .....182  
 Bergström's Pendulum Chronoscope.....75, 76  
 Bergström's Psychodometer .....113, 114  
 Bergström's Tachistoscope .....97  
 Bertillon's Anthropometric Instruments.....6  
 Bertillon's Calipers .....5, 6, S, 1  
 Bezold's Piston Whistle.....31  
 B & H Film Projector.....S, 33, 34  
 Bill's Animal Maze.....151  
 Binet's Cognizing Test.....153  
 Binet's Object Test.....134  
 Binet and Buzzenet Aesthesiometers .....48  
 Binet and Simon Color Test.....16  
 Binet and Simon Goddard Measuring Scale  
 for Intelligence .....170  
 Binet and Simon Line Suggestion Tests.....154  
 Binet and Simon Porteus and Hill Measuring  
 Scale for Intelligence.....173  
 Binet and Simon Stanford or Terman  
 Measuring Scale for Intelligence.....175  
 Binet and Simon Terman or Stanford  
 Measuring Scale for Intelligence.....175  
 Binet and Simon Unfinished Picture Tests.....165  
 Binet and Simon Visual Memory Tests.....154  
 Binet and Simon Weighted Cubes.....51, 52  
 Bixler's Intelligence Test Z.....174  
 Bixler's Manual .....174  
 Blake's Tuning Fork.....30  
 Blanton and Stinchfield Rating Sheet.....S, 11  
 Blanton and Stinchfield Speech Measurements 42-44  
 Blix's Temperature Cylinders.....50  
 Block's Aesthesiometer .....47  
 Boder's Metascope & Diploscope.....S, 2, 3  
 Boder's Tri-Dimensional Maze.....151  
 Boder's Voice Keys.....S, 11  
 Bogardus' Factory Machine.....63  
 Bogardus' Factory Test.....63  
 Boring's Limen Gauge.....S, 11  
 Boring's MN Maze.....147  
 Boring's Precision Cross Section Stamp.....S, 11  
 Boring and Titchener Articulated Facial Profile.....118  
 Bosworth's Tongue Depressors.....220  
 Bourdon's Disk .....26  
 Bowditch and Balzar Contact Clock.....208  
 Bowles' Stethoscope .....211  
 Boynton's Correlation Chart.....S, 1  
 Boynton's Manthonometer .....145  
 Brewer's Self-Measuring Scale.....S, 43  
 Brewer's Vocational Guidance Score Blanks.....181  
 Brewer and Lincoln Educational Information  
 Test .....S, 43  
 Brewer and Lincoln Instructions .....S, 43  
 Brewer and Lincoln Vocational Information  
 Test .....S, 43  
 Brewster's Stereoscope .....13  
 Brewster's Universal Stereoscope.....13  
 Brotemarkle's Comparison Test.....164  
 Brotemarkle's Manual .....164  
 Brotemarkle's Moral Concept Test.....164  
 Brotemarkle's Scoring Guide.....164  
 Burgess' Silent Reading Tests.....180  
 Burr and Metcalfe Revised I.E.R. Test.....S, 44  
 Burt's Association Test.....136

## C

- C. S. S. Co. Diagnostalite.....220  
 Camp's Mercury Manometer.....S, 58  
 Carmichael's Apparent Movement Apparatus 126, 127  
 Carmichael and Roberts Hands Lantern Slides S, 51  
 Carmichael and Roberts Hand Photographs.....S, 38  
 Carr and Robinson Chicago Psychodometer  
 112, 113, S, 24  
 Carrell and Reymert Phonetic Discrimination  
 Test, Mooseheart .....S, 46  
 Cason's Annoyance Test .....S, 32  
 Cason's Breathing Apparatus.....S, 58, 59  
 Cattell's Ergometer .....63

Cattell's Lip Key .....	46
Cattell's Voice Key .....	47
Chicago Psychodometer .....	112, 113, S, 24
Chicago Memory Drum .....	S, 17
Cleaton's General Mental Ability Test .....	180, 181
Cleaton's Manual .....	181
Cohn's Visual Acuity Test .....	8
Collin's Dynamometers .....	55, S, 12
C. U. Obstruction Box .....	S, 37
C. U. Scattered A Test .....	134
Cornell Form Board .....	129
Coronius, Schlosberg and Carmichael Moving Picture Film .....	S, 53
Courtis' Arithmetic Tests .....	179
Courtis' Standard Practice Tests in Reading .....	180
Crelle's Computing Tables .....	1
Crockett's Detroit Manual Ability Task .....	S, 43, 44
Crockett's Instructions .....	S, 44
Crockett's Manual .....	S, 44
Crockett's Record Blanks .....	S, 44, 49
Culler's Motion Picture Films .....	S, 54
Cunliffe's Detroit Route Chart .....	134
Curtis' Infant Record Blanks .....	190

**D**

Dallenbach's Temperature Grill .....	51
Dallenbach's Temperature Stimulator .....	51
Darrow's Behavior Research Photopolygraph S, 26-29	
Darrow's Reflexometer .....	S, 29, 30
Darrow's Table-top Electrodes .....	S, 30
Darrow's Universal Electrodes .....	S, 30
D'Arsonval Galvanometer .....	116
Davis' Manual .....	117
Davis' Personality Index and Success Guide .....	S, 32
Davis' Personal Problems Test .....	117
Dawson's Kinaesthetic Form Board .....	58
Dearborn's Chair Construction Tests .....	159
Dearborn's Color Form Test .....	127
Dearborn's Construction Puzzle .....	132
Dearborn's Triangle Form Board .....	132
Dearborn's Triangle Performance Test .....	131
Dearborn and Anderson Form Boards .....	130
Dearborn and Langfeld Tachistoscope .....	94
Dearborn and Whipple Ink Blot Imagination Test	157
Decroly's Matching Game .....	131
Decroly and Sutsman Buttoning Test .....	58
Delbouef's Disk .....	27
DeMoor's Weight Illusion Blocks .....	155
DeSanctis' Balls .....	16
DeSanctis' Cube .....	167
DeSanctis' Form Test .....	167
DeSanctis' Geometrical Forms .....	167
DeZeng's Schematic Eye .....	11
Dimmick and Ruckmick Vernier Chronoscope .....	73
Dockeray's Camera Shutter Tachistoscope .....	97-98
Dodge's Duplex Electric Recorder .....	S, 19
Dodge's Mirror Tachistoscope .....	96
Donder's Isoscope .....	28
Dorsey's Contact Pencil .....	107
Dorsey's Phonelescope .....	39
Dove and Wheatstone Pseudoscopes .....	15
Downey's Mirror Script Test .....	133
Drever and Collins Dearborn Triangle Form Board .....	132
Drever and Collins Domino Test .....	134
Drever and Collins Form Board .....	129
Drever and Collins Gaw Cube Test .....	161
Drever and Collins Healy & Fernald Construction Puzzle A .....	131
Drever and Collins Intelligence Tests .....	169
Drever and Collins Kohs Block-Design Test .....	168
Drever and Collins' Little Bo-Peep and her Sheep Test .....	158
Drever and Collins Size and Weight Test .....	52
DeBois and Reymond Inductorium .....	213, 214
Dudgeon's Sphygmograph .....	211
Dunham's Arrow Board Test .....	161
Dunlap's Balanced Relay .....	110
Dunlap's Chronoscopes .....	83, 84, S, 14
Dunlap's Master Key .....	110
Dunlap's "Nela" Color Perception Test .....	S, 5, 6
Dunlap's Pneumatic Reaction Key .....	110
Dunlap's Pressure Reducing Capsule .....	99
Dunlap's Stimulus Key .....	110
Dunlap's Tapping Apparatus .....	63

Dunlap's Visual Stimulus .....	112
Dunlap's Voice Key .....	47

**E**

Ebbinghaus' Aesthesiometer .....	47
Ebbinghaus' Completion Test .....	159
Edeimann's Tuning Fork .....	30
Eder and Jung Association Test .....	136
Edinburgh University Anatomical Stereograms S, 4	
Elliott's Ear Protectors .....	31
Ellis' Recall Test .....	153
Ellis' Visual Memory Tests .....	154
Emschwiler's Knowledge and Com- prehension Charts .....	134
Engleking and Eckstein Perimeter Paper .....	19
Ewald's Chronoscope .....	86, S, 20, 21
Exner's Neuromobimeter .....	69-70
Exner's Otolith Organs .....	194, 195
Exner's Semicircular Canal Model .....	194, 195

**F**

Farnsworth and Roberts Demonstration Board .....	149
Fechner's Double Sound Pendulum .....	37
Fechner's Weights .....	53
Feleky's Photographs .....	167
Feleky's Photographs Lantern Slides .....	S, 51
Ferguson's Form Boards .....	168, 169
Fernald's Discrimination Weights .....	52
Fernald's Ethical Discrimination Test .....	163
Fernald's Ethical Perception Test .....	123
Fernald's Recognition Memory Test .....	152
Fernald's Tapping and Three-Hole Board .....	63
Fernald's Tests .....	169
Fernald's Volometer .....	64
Fernberger and Paschal Discrimination Weights	52
Ferree and Rand Daylight Photometer .....	52
Flees' Box .....	12
Fleischl's Nonpolarizable Brush Electrodes .....	219
Fleischl's Rheonome .....	215
Ford's Color Projection Boxes .....	S, 6
Ford's Disk-Spinner .....	S, 33
Ford's Hooded Screen .....	S, 33
Ford's Knee-Jerk Apparatus .....	S, 13
Ford's Lantern Slide Maze .....	S, 50
Ford's Lantern Slides .....	S, 50
Ford's Modification of Metfessel & Tiffin Phono-Projectoscope .....	S, 10
Ford's Motion Picture Films .....	S, 52, 53
Ford's Spectrum Slide .....	S, 50
Ford's Tachistoscopic Lantern Slide .....	S, 50
Ford's Truncated Pyramid .....	S, 5
Forster's Multiple-Choice Reaction Test .....	S, 47, 48
Foster's Anagram Cards .....	157
Foster's Automatograph .....	64
Foster's Cardboard Screen .....	148
Foster's Chinese-English Vocabulary .....	141
Foster's Colored Papers .....	20
Foster's Knee-Jerk Apparatus .....	65
Foster's Letter Squares .....	157
Foster's Mazes .....	147
Foster's Mirror-Drawing Test .....	143
Foster's Mueller & Lyer Illusion Board .....	123
Foster's Olfactory Stimuli .....	41
Foster's Poetic Selections .....	141
Foster's Poetry and Nonsense Verses .....	141
Foster's Reflex Hammer .....	65
Foster's Rubber Stamp .....	51
Foster's Skeleton Word Cards .....	157
Foster's Taste Stimuli .....	42
Foster's Temperature Cylinders .....	50
Foster's Time Sense Apparatus .....	90
Foster's Turkish-English Vocabulary .....	141
Foster's Vernier Chronoscope .....	71
Foster's Weighted Envelopes .....	52
Francke's Hand and Wrist Plethysmograph .....	212
Francke's Volumetric Sphygmograph .....	211
Francois-Frank's Cannulae .....	210
Franz's Absurdities Test .....	166
Franz's Aesthesiometer .....	47, 48
Franz's Apprehension Test .....	134
Franz's Association Test .....	138
Franz's Association Test (Objects) .....	138
Franz's Cardboard Perimeter .....	S, 6
Franz's Discrimination Weights .....	52
Franz's Exposure Apparatus .....	90
Franz's Hand and Arm Rest .....	103



Franz's Maze Test .....	125	Hall's Frog Board Myograph.....	216, 217
Franz's Memory Test .....	153	Hall's Frog Heart Lever.....	217
Franz's Mental Process Test .....	165	Hall's Mercury Manometers .....	210
Franz's Neurological and Psychiatric Tests.....	169	Hall's Paper Holder .....	211
Franz's Olfactory Stimuli .....	41	Hall's Trial Set .....	10
Franz's Perimeter .....	S, 6	Hampton Court Maze.....	61
Franz's Protractor .....	3	Hansen's Auditory Motor Action Stimulus.....	60
Franz's Rubber Bulb .....	63	Hanson's Stimulus .....	60
Franz's Stimuli Card .....	122	Hansen's Commutator .....	60
Franz's Target Board .....	60	Hartford Curative Workshop Completion Test.....	159
Franz's Taste Stimuli .....	42	Hartman Bivalve Nazal Specula.....	220
Franz's Weights .....	49	Hathaway's Pendulum Chronoscope.....	74
Franz and Kline Perimeter.....	19	Hathaway's Psychogalvanoscope .....	116
Fraser's Scoring Guide .....	122	Hayes' Instruction Box .....	S, 36
Freeman's Dot Slips .....	94	Hayes' Problem Box .....	S, 35
Freeman's Exposure Slips .....	94	Hayes and Dewey Automobile Construction Test.....	161
Freeman's Eye Observation Mirror.....	11	Hayes and Dewey Narrative Pictures Test.....	165
Freeman's Figures .....	S, 36	Hayes and Healy Instruction Box.....	134
Freeman's Handwriting Scale .....	178	Head's Algesimeter .....	S, 12
Freeman's Immediate Memory Test.....	152	Healy's Pictorial Completion Tests.....	157, 158, S, 38
Freeman's Mirror-Drawing Apparatus .....	143	Healy's Scoring Card .....	154
Freeman's Puzzle Box .....	127	Healy's Visual Memory Tests.....	154
Freeman's Rote Memory Cards.....	152	Healy and Bronner "Assuage" or Testimony Test.....	135
Freeman's Stimulus Cards .....	144	Healy and Bronner Learning Tests .....	142
Freud's Association Test .....	136	Healy and Fernald Association Test .....	137
Frey, von, Aesthesiometer .....	47	Healy and Fernald Binder .....	190
Frey, von, Limen Gauge .....	49	Healy and Fernald Code Test .....	140
Frey, von, Sphygmograph .....	211	Healy and Fernald Construction Puzzles .....	131, 132
Freyd's Teaching Graphic Rating Scale.....	189	Healy and Fernald Cross Line Test B.....	140
Freyd's Occupational Interest Blanks..	181, 182, S, 43	Healy and Fernald Information Test .....	178
Freyd's Scoring Stencil .....	189	Healy and Fernald Learning Test .....	140
Frois and Wittman Photographs .....	S, 38	Healy and Fernald Memory Test .....	154
Furfey's Developmental Age Test.....	S, 32	Healy and Fernald Motor Co-ordination or Tapping Test .....	59
Furfey's Manual .....	S, 32	Healy and Fernald Picture Form Boards 128, 129, 157	157
<b>G</b>			
Galton's Frequency Curve Apparatus.....	1	Healy and Fernald Scoring Blanks .....	154
Galton's Whistles .....	32	Healy and Fernald Tabular Scoring Record.....	189
Garth's Blind Puzzle Box.....	151	Healy and Fernald Tests .....	170
Garth's Purposive Thinking Test.....	S, 38	Healy, Fernald & Hayes Puzzle Box.....	126
Geiger's Complication Clock.....	165	Hecht's Binocular Color Mixer.....	S, 7
Geissler Tube .....	S, 34	Heidbreder's Manual .....	S, 33
Gesell's Preschool Child Tests.....	169, 170	Heidbreder's Minnesota Personal Traits Rat- ing Scales .....	S, 33
Gilbert's Suggestion Blocks .....	155	Heidbreder's Stencil .....	S, 33
Gilbert's Tone Tester .....	31	Heilbronner's Apperception Test .....	157
Gilbert and Whipple Discrimination Weights.....	52	Helmholtz's Phakoscope .....	S, 2
Glueck's Ship Picture Form Board.....	132	Helmholtz's Stereoscope Tubes.....	13
Goddard's Binet & Simon Aesthetic Judgment Test .....	166	Hering's After-Image Apparatus .....	20
Goddard's Binet & Simon Cognizing Test.....	153	Hering's Binocular Color Mixer.....	22
Goddard's Binet & Simon Line Comparison Tests	162	Hering's Color Circle .....	23
Goddard's Binet & Simon Measuring Scale for Intelligence .....	170	Hering's Color Disks .....	22
Goddard's Binet and Simon Sentence Test.....	159	Hering's Color Perception Test .....	18
Goddard's Binet and Simon Test Cards and Pictures .....	170	Hering's Contrast Apparatus .....	26
Goddard's Form Board .....	129	Hering's Disks .....	28
Goddard's Picture Memory Tests.....	153	Hering's Dropping Test .....	25
Goddard's Record Blanks .....	189	Hering's Mirror Haploscope .....	28
Goddard's Test Cards .....	133	Hering's Papers .....	22, 24, 25, S, 7
Goddard's Visual Memory Test.....	154	Herrick's Pains & Causes, Lantern Slide.....	S, 51
Goddard or Vineland Adaptation Board.....	163	Hevner's Oregon Musical Discrimination test, Phonograph Records .....	S, 46
Gopalaswami's Circuit Breaker .....	110	Hevner's Record Blanks.....	S, 46, 49
Gopalaswami's Four-Finger Reaction Key.....	110	Hickson's Photographs .....	167
Gopalaswami's Mirror-Drawing Apparatus .....	144	Higgins' Waterproof India Ink .....	51
Gopalaswami's Mirror-Groove Apparatus .....	144	Hill's Ambiguous Figure, Lantern Slide.....	S, 51
Gopalaswami's Rotary Switch .....	110	Hipp's Chronoscope .....	84, 85
Gray's Stereoscopic Disk .....	39	Hipp's Psychodometer .....	S, 24, 25
Gregg's Ataxiagraph .....	S, 13	Hipp's Sound Stimulators .....	37
Griffitts' Imagination Test.....	157	Holcombe's Case History Booklet.....	45
Guhin's Card Changer .....	91, 92, S, 17	Holcombe's Pedigree Charts .....	45
Guidi's Warmth Tester.....	155	Holley's Sentence Vocabulary Scale.....	178
Guilford's Articulated Full Face Facial Model..	S, 31	Hollingworth and Poffenberger Photographs.....	153
Guthrie's Mercury Manometer.....	210	Hollingworth and Poffenberger Photographs, Lantern Slides .....	S, 51
Gutzmann and Scripture Pneumograph.....	S, 58	Holmgren's Worsteds .....	17
Gwinn and Thurstone Ingenuity Test.....	162	Homan's Faciometer .....	5
Gwinn and Thurstone Manual .....	162	Homan's Slide Rule .....	2
Gwyn's Triangle Test .....	131	Howard and Dohman Depth Perception Apparatus .....	S, 7, 8
<b>H</b>			
Hackl-Means Association Test.....	137	Howell's Psychogalvanoscope .....	S, 25, 26
Haines' Manual .....	172	Hubbard's Freyd Occupational Interest Blank S.	43
Haines' Mental Alertness Tests.....	171, 172	Huey's Record Blanks .....	190
Haines' Scoring Guide .....	172	Hull's Engine-Lathe Test .....	188
Hall's Belt Spirograph .....	213	Hull's Hypnotic Apparatus .....	S, 37
Hall's Cannulae .....	210	Hull's Radiometer .....	5
		Hunter's Maze .....	126
		Hutchinson's Wet Spirometer.....	212, 213

**I**

I.E.R. Assembly Test for Girls.....	185, 186
I.E.R. Manual (Toops and Staff).....	186
I.E.R. Scoring Blanks .....	190
Ishihara's Color Perception Test.....	17, S, 6
Israel's Scoring Stencils.....	142

**J**

Jacquet's Graphic Chronometers .....	82, 83
Jacquet's Laboratory Stopwatches .....	81, 82, S, 14
Jacquet's Metronome .....	71
Jacquet's Optical Chronometer .....	82
Jacquet's Stop-Watches .....	77, 78, S, 14
Jaeger's Visual Acuity Test.....	10
James' Antirrhoeoscope or Artificial Waterfall.....	21
Jastrow's Aesthesiometer .....	48
Jastrow's Automatograph .....	64
Jastrow's Break Key .....	111
Jastrow's Five-Finger Reaction Key.....	110
Jastrow's Memory Apparatus .....	91, 92
Jastrow's Multiple Image Apparatus .....	12
Jastrow's Perspectoscope .....	13
Jastrow's Sorting Tests .....	61
Jastrow's Speech Key .....	46
Jastrow's Trilling Key .....	63
Jastrow's Weights .....	49
Jenkins and Warden Motivation Apparatus.....	S, 37
Johnson's Gnathodynamometer .....	56
Johnson's Walking Board.....	62
Jones' Barany Chair .....	S, 14
Jones' Personnel Questionnaires .....	119, S, 32
Jones' Visual Recognition of Forms.....	153
Judd's Psychology Lantern Slides.....	199
Jung's Association Tests.....	136

**K**

Kelley's Constructive Ability Test.....	160
Kelley's Record Sheets .....	161
Kelley's Stereoscopic Photographs .....	161
Kelley and Trabue Language Completion Test.....	158
Kelley and Trabue Manual .....	158
Kelley, Trabue and Spivak Language Completion Test .....	158
Kelley, Trabue and Spivak Manual .....	158
Kellogg's Motion Picture Films.....	S, 53, 54
Kemp's Maxim Test .....	S, 38
Kempf's Diagonal Form Board.....	131
Kent's Color Cube Tests .....	168
Kent's Danvers Eight-Task Series Photographs .....	S, 36
Kent's Modified Dearborn & Anderson Form Board .....	S, 36
Kent's Word Building Test.....	159
Kent and Franz Maze Test .....	125
Kent and Rosanoff Association Tests .....	136
Kent and Shakow Clinical Form Board .....	175
Kent and Shakow Industrial Form Board .....	175
Kent and Shakow Intelligence Tests .....	172, S, 41
Kibbe's Tachistoscope .....	193
Kiesow's Temperature Stimulator.....	51
King and Gold Association Test .....	136
Kirkpatrick Portraits .....	198, S, 50
Kirkpatrick and Whipple Vocabulary Test.....	178
Kirkwood's Association Learning Test.....	141, 142
Kirkwood's Cumulative Record Blanks.....	142, 148, 190
Kirkwood's Record Blanks .....	142, 148, 190
Kirkwood's Substitution Form Board.....	148
Kirschmann's Photometer .....	27
Kline's Ataxiagraph .....	67, S, 13
Kline's Cartridge Discrimination Weights.....	53
Kline's Distributing Case .....	145
Kline's Exposure Chart .....	123
Kline's Mazes .....	149, 150
Kline's Memory Cards .....	152
Kline's Object Cards .....	153
Kline's Photographs .....	S, 38
Kline's Problem Blanks .....	123
Kline's Racket Paddle .....	S, 37
Kline's Size-Weight Illusion .....	155
Kline's Stimulus and Test Cards.....	91
Kline's Weights .....	53
Klopsteg's Chronoscope .....	86, 87
Klopsteg's Psychodometer .....	114
Knox's Action Picture .....	153
Knox's Block-Design Test .....	167, 168
Knox's Children's Picture Book.....	153
Knox's Comparison Test .....	162

Knox's Cube Imitation Test.....	156
Knox's Diagonal Frame Test.....	131
Knox's Dot Counting Test.....	123
Knox's Geometrical or Jig-saw Test.....	132
Knox's Imagery Test .....	157
Knox's Imbecile Test .....	132
Knox's Imitation Tests .....	156
Knox's Immigration Tests .....	172
Knox's Memory Test .....	153
Knox's Moron Test .....	133
Knox's Record Cards .....	190
Knox's Test Card .....	133
Knox's Visual Memory Test .....	154
Knox and Kempf Feature Profile Test.....	132
Koenig's Difference-Tone Apparatus .....	33
Koenig's Resonators .....	31
Kohs' Circular Slide Rule .....	2
Kohs' Ethical Discrimination Test.....	163
Kohs' Manual .....	164
Kohs' Scoring Table and Mental Age Equivalents .....	168
Kraepelin Association Tests .....	139
Kraepelin Electric Pencil .....	111
Kraepelin Keys .....	139
Kraepelin Stereograms .....	15
Kronecker's Cannula .....	210
Kronecker's Mercury Manometer .....	210
Kronecker's Metronome .....	71
Kuehne's Demonstration Eye .....	11

**L**

Ladd-Franklin Color Charts.....	197
Langfeld and Allport Aesthesiometer .....	48
Langfeld and Allport Blind Spot Cards.....	10
Langfeld and Allport Figures .....	53
Langfeld and Allport Olfactory Stimuli .....	41
Langfeld and Allport Sound Cage or Perimeter.....	36
Langfeld and Allport Touch Weights .....	50
Lashley's Saliometer .....	65
Lauer's Electrodes .....	S, 30
Lauterbach's Mirror-Tracing Test .....	S, 36
Lazerte's Analysis of Reasoning Apparatus.....	S, 38
Leach and Washburn Association Test .....	136
Leary and Dry Manual .....	179
Leary and Dry Technical Information Test for Girls .....	179
Lehmann's Arm Plethysmograph .....	212
Lehmann & Titchener Acoumeter .....	34
Lieb and Becker Chronometer .....	83
Likert and Quasha Paper Form Boards.....	S, 46
Lincoln's Hollow Square Form Board.....	132
Lingle's DuBois-Reymond Spring Myograph .....	217
Lingle's Inductarium .....	214
Link's Address Copying Test.....	182
Link's Alphabetical Filing Test.....	165
Link's Context Tests .....	159, 182
Link's Cube Construction Test.....	161
Link's Dexterity Tests .....	56
Link's Dial Feed Machine Operators' Test.....	187, 188
Link's Dictation and Typing Test.....	182
Link's Gunsmith's Trade Questions.....	184
Link's Literacy Test .....	178
Link's Machine Tool Operators' Arithmetical Test .....	S, 43
Link's Oral Directions Test.....	133
Link's Posting Tests .....	184
Link's Record Blanks .....	161
Link's Record Cards .....	190
Link's Simple Arithmetical Test .....	178
Link's Sorting Tests .....	61, 62
Link's Spatial Perception Test.....	127
Link's Spelling Test .....	178
Link's Substitution Tests .....	140
Link and Connelly Grammar Tests .....	178, 179
Link and Gilbert Comptometer Adding Test.....	182
Link and Gilbert Comptometer Extending Test.....	182
Link and Keeler Jig and Fixture Designers' Test.....	184
Link and Keeler Machinists' Association Test.....	184
Link and Keeler Machinists' Context Test.....	184
Link and Keeler Machinists' Trade Questions.....	184
Link and Keeler Toolmakers' and Apprentices Arithmetic Test .....	184
Link and Keeler Toolmakers' Context Test.....	184
Link and Keeler Toolmakers' Part-Whole Test .....	183, 184
Link and Keeler Toolmakers' Vocabulary Test.....	183

Link and Koehne Easy Topical Filing Test.....	182	Meyer's Reversing Apparatus .....	147, 148
Loughran's Cross Frame Test.....	131	Meyer's Rhythm Frame .....	90
Lowe and Shimberg Key .....	178	Meyer's Rhythm Tachistoscope .....	97
Lowe and Shimberg Scaled Information Test .....	178	Meyer's Weight-Illusion Cylinders .....	155
Lowell's Visual Acuity Test .....	8	Michel's Chart of Arterial, Venous and Nervous Systems .....	196, 220
Ludwig's Bent Tube Stylus .....	100	Michels' Chart of Muscular System.....	196, 198
Ludwig's Song Whistle .....	S, 9	Michels' Chart of Osteology .....	196, 197
Ludwig's Sphygmograph .....	211	Michels' Chart of Spine and Spinal Nerves.....	196, 199
Ludwig's Tropostereoscope .....	13	M.S.U. Demonstration Maze Board .....	S, 37
Ludwig and Hall Cannulae.....	212	M.S.U. Films .....	S, 51, 52
Lund's Manoptometer .....	S, 3	Miles' A-B-C Vision Test .....	S, 3
Lyon's Capillary Electrometer .....	215	Miles' Ataxiameter .....	S, 13
<b>M</b>			
Macmillan's Cross-Line Test A.....	140	Miles' Duplicate Two-story Maze.....	150
Maddox's Multiple Rod .....	12	Miles' High-relief Finger Maze .....	150
Maimud's Finger Electrodes.....	116	Miles' Pendulum Pursuitmeter .....	S, 13
Marey's Arterial Elasticity Model.....	S, 49, 50	Miner's Analysis of Work Interest Blanks.....	181
Marey's Cardiograph .....	212	Minnesota Block-Packing Test .....	145
Marey's Pneumograph .....	212, 213	Minnesota Mechanical Aptitude Tests .....	185
Marey's Recording Tambour .....	98	Minnesota Paper Form Boards.....	187, S, 46
Marston's Children's Introversion- Extroversion Tests .....	S, 32, 33	Minnesota Scoring Stencils .....	187
Marston's Record Blanks .....	S, 49	Minnesota Sorting Test .....	62
Martius' Disks .....	28	Minnesota Spatial Perception Test .....	127
Martius' Rods .....	163	Mira's Perceptoquimeter .....	188
Martius' Screens .....	163	Moncrieff's Card Changer .....	S, 16, 17
Martius'-Matzdorff Stereograms .....	14	Monroe's Diagnostic Reading Examination.....	S, 11
Masson's Disk .....	26	Monroe's Manual .....	S, 11
Matthews' Myocardiograph .....	218	Monroe's Record Blanks .....	S, 11, 49
Maxfield's Colored Cube Test.....	168	Monroe's Silent Reading Tests .....	163
Maxfield's Form Board .....	129	Montessori's Cylinder Test .....	163
McCallie's Audiometer .....	35	Montessori's Tower .....	156
McCallie's Visual Acuity Tests .....	S, 9	Moore's Revised N.I. of I.P. Clerical Test.....	S, 46
McCormick's Social Adequacy Measuring Scale S, 33		Moore's Convertible Stereograms .....	S, 4
McDonald's Algometers .....	54	Mooseheart Laboratory Polygraph .....	S, 21, 22
McElwee's Primary Cylinder Board.....	S, 38	Mooseheart Phonetic Discrimination Test.....	S, 46
McFarlane's Coat Test .....	162	Mosso's Ergograph .....	63
McFarlane's Cradle Test .....	159	Müller's Three-Hole Test .....	58
McFarlane's Frock Test .....	162	Müller and Lyer Illusion Boards.....	123
McFarlane's Painted Cube Test.....	161	Münsterberg's Attention Test .....	122
McFarlane's Wheelbarrow Test .....	159	Münsterberg's Arm Movement Apparatus.....	53
Means' Association Test .....	137	Münsterberg's Pseudoptics .....	252
Merrill-Palmer Picture Form Boards .....	129	Mulhall's Memory Material .....	152
Merrill-Palmer and Pintner Manikin Test.....	131	Munsell's Papers .....	25
Merrill-Palmer Preschool Performance Tests .....	174	<b>N</b>	
Metfessel's After-Image Lantern Slide.....	S, 51	Nagel's Anomoloscope .....	18
Metfessel's Association Stimulus Card.....	S, 36	Nagel's Color Perception Test.....	17
Metfessel's Binet and Buzzenet Aesthesiometer		N.I.I.P. Clerical Test .....	187
Rack .....	S, 11	N.I.I.P. Foot and Hand Co-ordination Press.....	189
Metfessel's Balanced Relay .....	S, 34	N.I.I.P. Form Building Test.....	187
Metfessel's Brightness Disk .....	S, 8	N.I.I.P. Form Relations Test .....	127
Metfessel's Brightness Discrimination Device.....	S, 8	N.I.I.P. Intelligence Tests .....	172
Metfessel's Color Preference Cards .....	S, 38	N.I.I.P. Manuals .....	172, 187
Metfessel's Discrimination Weights .....	S, 12	N.I.I.P. Strip Building Test .....	187
Metfessel's Discrimination Weight Rack.....	S, 12	N.I.I.P. Thimbles Test .....	186
Metfessel's Electrically Maintained Tuning Fork.....	69	N.I.I.P. Touch Placing Test .....	189
Metfessel's Fixation Cross .....	S, 6	Nela Color Perception Test .....	S, 5, 6
Metfessel's Guilt Stimuli .....	S, 36	Neumann's Plastographs .....	S, 5
Metfessel's Habit Interference Test.....	S, 13	Newman's Blueprint Reading Test .....	S, 44
Metfessel's Lantern Slides .....	S, 51	Newman's Engine-Lathe Test Blanks .....	S, 48
Metfessel's Mirror-Tracing Apparatus.....	S, 36	Newman's Micrometer Reading Test.....	S, 45
Metfessel's Peripheral Vision Cards.....	S, 6	N.Y.S.B.o.C. Boat Test .....	161
Metfessel's Positive After-Image Apparatus.....	S, 6	N.Y.S.B.o.C. Cancellation Test .....	122
Metfessel's Psychodimeter .....	S, 24	N.Y.S.B.o.C. Memory Test .....	153
Metfessel's Pursuit Disk .....	S, 13	N.Y.S.B.o.C. Mental Tests .....	172
Metfessel's Record Blanks .....	S, 46, 49	N.Y.S.B.o.C. Peg Board Tests .....	166
Metfessel's Rocker .....	S, 8	N.Y.S.B.o.C. Peg Design Board .....	146
Metfessel's Shade Disk .....	S, 8	N.Y.S.B.o.C. Recognition Test .....	153
Metfessel's Simplified Barany Chair .....	S, 14	N.Y.S.B.o.C. Syllogism Test .....	166
Metfessel's Sound Effects, Phonograph Record S, 45		N.Y.S.B.o.C. Time-Telling Test .....	181
Metfessel's Stroboscopic Timing Disk.....	S, 16	N.Y.S.B.o.C. Tower Test .....	57
Metfessel's Target .....	S, 14	Neymann and Kohlstedt Introversion- Extroversion Test .....	120
Metfessel's T-F-L Puzzles .....	S, 36	Neymann and Kohlstedt Manual .....	120
Metfessel's Tint Disk .....	S, 8	Norsworthy Intelligence Tests .....	172
Metfessel's Word Stimulus Cards.....	S, 36	N. U. Ether Jar Regulator .....	208
Metfessel and Hovey Immediate Memory Test, Phonograph Record .....	S, 37	N. U. Fixing Bath .....	106
Metfessel and Hovey Record Blanks .....	S, 37, 49	N. U. Gas Burner .....	106
Metfessel and Musgrave Motion Picture Films S, 53		<b>O</b>	
Metfessel and Tiffin Phonoprojectoscope .....	39	O'Connor's Finger Dexterity Apparatus .....	S, 47
Meumann's Time Sense Apparatus .....	90	O'Connor's Tweezer Dexterity Apparatus.....	S, 47
Meumann's Tooth or Biting Key .....	47	O'Connor's Wiggly Block .....	S, 43
Meyer's Discrimination Weights .....	53	Ontario Hospital Record Blanks for Portens Mozes .....	S, 49
Meyer's Finger Mazes .....	147	O.S.U. Modified Yerkes Multiple Choice Apparatus .....	S, 37
Meyer's Induction Boxes .....	19		

## P

Packard's Plastographs	15
Papurt's Form Board	S, 35, 36
Papurt's General Information Score Sheet	S, 42
Papurt's Personal Data Sheet	S, 31
Parson's Manoptoscope	12, 13
Patinsco Steadiness Tester	66
Pavlov's Motion Picture Film	S, 51
Payson's Indelible Ink	51
Perrin's Motor Co-ordination Test	149, 150
Peterson's Rational Learning Test	140
Phares' Nonpolarizing Electrodes	S, 30
Phillip's Color Mass Discrimination Test	S, 38
Phillip's Color Perception Test	S, 5
Phillip's Electric Circuit Tracing Test	S, 45
Phillip's Scoring Sheets	S, 5
Pilling's Stethoscopes	211
Pintner's Manikin Test	131
Pintner and Knox Cube Imitation Tests	156, S, 41
Pintner and Paterson Adaptation Board	S, 38
Pintner and Paterson Form Boards	129, 130, S, 41
Pintner and Paterson Knox & Kempf Feature Profile Test	132
Pintner and Paterson Performance Tests	135, 172, 173
Pintner and Paterson Picture Form Boards	129
Pintner and Paterson Record Blanks	190
Pintner and Paterson Woodworth & Wells Substitution Tests	140, S, 41
Pintner and Toops Directions Test	134
Poffenberger's Adjustable Figures	166
Poffenberger's Aesthetic Judgment Test	166
Poffenberger's Fixation Card	20
Poffenberger's Imagery Blank	157
Poffenberger's Learning Material	141
Poffenberger's Learning Test	146
Poffenberger's Memory Span Tests	152
Poffenberger's Nonsense Material	141
Poffenberger's Nonsense Syllables	S, 36
Poffenberger's Recognition Test	S, 37
Poffenberger's Substitution Test	140
Poffenberger's Weights	53
Pohls' Mercury Commutator or Pole Changer	216
Politzer's Acoumeter	34
Porter's Circulation Apparatus	S, 59
Porter's Ergograph	63
Porter's Finger Plethysmograph	S, 58
Porter's Muscle Warmer	S, 59
Porter's Respiration Apparatus	S, 59
Porteus' Craniometer	5
Porteus' Maze Tests	125, 133, 173
Porteus and Hill Binet and Simon Measuring Scale for Intelligence	173
Porteus and Hill Binet and Simon Picture Interpretation Test	133
Porteus and Hill Binet and Simon Test Cards and Pictures	173
Porteus and Hill Record Blanks	190
Poull, Bristol, King and Peatman Randall's Island Performance Test	S, 41
Pressey's Manuals	117, 179
Pressey's Sports Information Test	179
Pressey's X-O Tests	179
Pyle's Association Tests	137, 138
Pyle's Ball Tossing Apparatus	146
Pyle's Completion Test	159
Pyle's Digit-Alphabet Test	139
Pyle's Digit-Symbol Tests	139, 140
Pyle's Keys	139
Pyle's Label Cards	147
Pyle's Learning Apparatus	146
Pyle's Learning Tests	140, 141
Pyle's Logical Memory Test	153
Pyle's Manthanometer	145
Pyle's Mirror-Drawing Test	142
Pyle's Perception Test	123
Pyle's Question Blanks	140, 141
Pyle's Reading Span Test	S, 18
Pyle's Record Blanks	152, 190
Pyle's Rote Memory Test	152
Pyle's Spot Pattern Test	S, 36
Pyle's Symbol-Digit Test	139

## Q

Quincke's Tubes	33
-----------------	----

## R

Randall's Island Performance Tests	S, 41
------------------------------------	-------

Ranschburg's Make or Break Key	111
Ranschburg's Memory Apparatus	92
R.C.A. Victor Phonograph "Electrola"	S, 45, 46
Ream's Motility or Tapping Apparatus	63
Reichert's Double Automatic Stimulus Key	216
Reichert's Vibrating Reed	69
Reid's Müller-Lyer Illusion Board	123
Renshaw's Polygraph	108
Renshaw and Weiss Pursuitmeter	S, 13
Reymert and Kohn Mooseheart Laboratory Polygraph	S, 21, 22
Reymert and Scripture Dynamometer	S, 12
Richards' Achievement Test in Biology	179
Richards' Manual	180
Richards' Scoring Guide	180
Richmond's Directions	S, 32
Richmond's Psychotic Questionnaire	S, 32
Richmond's Woodworth & Cady Personal Data Sheet	S, 31
Roback's Comprehension Test	S, 41
Roback's Manuals	162, 177, S, 41
Roback's Scientific Ingenuity and Juristic Aptitude Test	162
Roback's Superior Adult Test	177
Roemer's Exposure Apparatus	91
Roemer's Voice Key	47
Rogers' Association Test	137
Rogers' Record Blanks	190
Rogers' Stenographic and Typing Test	182
Rorschach's Ink Blot Test (Psychodiagnostik)	S, 31
Rosanoff, Martin & Rosanoff Association Test	136
Rosenstein's Disk Test	S, 39
Rossolimo's Mental Tests	174
Rubin's Goblet—Lantern Slide	S, 51
Ruckmick's Electrodes	S, 30
Ruckmick's Photographs	167
Ruckmick and Greenwald Moving Picture Film	S, 54
Ruckmick and Paterson Non-polarizing Electrodes	S, 30
Rudolph's Photographs	167
Ruger's Mechanical Puzzles	146
Ruth's Electrical Inclination Test	186
Ruth's Manual	186
Ruth's Record Blanks	186, 190
Ruth's Scoring Guide	186

## S

Sanford's Dark Box	26
Sanford's Krypteon	90
Sanford's Vernier Chronoscopes	72, 73
Scheidemann's Manuals	S, 32
Scheidemann's Tact Test	S, 32
Scheidemann's Teachers' Judgment in Child Discipline Test	S, 48
Scheidemann's Teachers' Professional Judgment Test	S, 48
Schumann's Illusion—Lantern Slide	S, 51
Schwartz's Manuals	S, 33
Schwartz's Psychiatric Record Blank	S, 49
Schwartz's Social Situation Pictures Tests	S, 33
Schweigger's Perimeters	19
Scott's Three-hole Tapping Apparatus	58
Scott Co.'s Filing Test	182
Scott Co.'s Mental Alertness Tests	177, 178
Scripture's Apparatus	45, 46, 220
Scripture's Book Stereoscope	S, 4
Scripture's Color Sense Tester	16
Scripture's Finger Dynamometer and Dynamograph	S, 12
Scripture's Lamp Battery	90
Scripture's Noiseless Contact Key	111
Scripture's Strobillion	220
Scripture's Touch Key	111
Scripture's Touch Weights	49
Scripture and Dessoir Reaction Key	111
Seashore's Audiometers	33, 34
Seashore's Correlation Machine	1, 2
Seashore's Musical Talent Test	187
Seashore's Phonograph Chronoscope	85
Seashore's Phonograph Records	187
Seashore's Precision Target	60
Seashore's Reaction Key	110
Seashore's Record Blanks	190
Seashore's Rhythm Meter	89
Seashore's Rhythm Meter Paper Disks	89

Seashore's Spark Chronoscope .....	74	Stutsman's Little Pink Tower Test.....	156
Seashore's Stimulus Key .....	110	Stutsman's Nested Cubes .....	134
Seashore's Suggestion Weights .....	155	Stutsman's Picture Form Boards.....	128, 130
Seashore's Time Sense Apparatus .....	89	Stutsman's Pre-school Performance Tests.....	174
Seashore's Tonoscopes .....	38, 39, S, 10	Stutsman's Pyramid Test .....	156
Seashore's Tuning Forks .....	29	Stutsman's Record Blanks .....	191
Seashore and Koerth Pursuit Apparatus...60, S, 13		Stutsman's Star Copying Test .....	S, 37
Seashore and Wickham Musical Touch		Stutsman's Stick and String Test.....	59
Audiometer .....	36, S, 10	Sumner's Pneumograph .....	212, 213
Seguin and Goddard Form Boards.....129, S, 35, 40		Sweet's Psychanalytical Personality Chart...S, 33	
Seguin, Goddard and Sylvester Form Board.....129			
Seguin, Witmer and Sylvester Form Board.....129			
Seitz's Visual Acuity Test .....	8		
Seward's Phi-phenomena Apparatus .....	S, 35		
Shakow and Kent Association Tests .....	139		
Shakow and Kent Essential Difference Test.....164			
Shakow and Kent Worcester Form			
Boards .....	175, 176, S, 40		
Sharp's Moral Reaction Test.....	163		
Shaw's Cradle Test .....	159		
Shaw's Drug Store Picture Form Board.....158			
Shellow's Manual .....	184		
Shellow's Stenographers' and Typists'			
Intelligence Test .....	184		
Sherrington and Starling Kymographs.....104, 105			
Simpson's Occupational Inventory.....S, 42			
Skeels' Form Boards .....	S, 39, 40		
Skeels' Pre-school Children's Tests.....S, 39, 40			
Skeels' Record Blanks .....	S, 40		
Skeels' Scoring Blanks .....	S, 40		
Skeels' Table Standard .....	S, 40		
Slaughter's Portable Test Card Illuminator.....10			
Smedley's Cephalometer .....	5		
Smedley's Dynamometers .....	56		
Smedley's Dynamometer and Dynamograph.....56			
Smith's Chamois-covered Zinc Electrodes.....116			
Smith's Speed Reducer .....	89		
Snoddy's Mirror-Drawing Apparatus .....	150		
Sommer's Tri-dimensional Analyser.....67			
Spearman's Aesthesiometer .....	48		
Spielman's Record Sheets .....	57		
Spielman's Rounds Placing Test .....	56		
Spielman's Strip Building Test .....	187		
Spielman's Thimbles Test .....	185, 186		
Sprague and Knox Form Boards .....	130		
Stanford or Terman Abbreviated Record Card...190			
Stanford or Terman Binet and Simon			
Discrimination of Form Test .....	164		
Stanford or Terman Binet and Simon			
Measuring Scale for Intelligence.....175			
Stanford or Terman Binet and Simon			
Unfinished Pictures Test .....	165		
Stanford or Terman Boxes .....	157		
Stanford or Terman Cognizing Test .....	153		
Stanford or Terman Fables Test .....	157		
Stanford or Terman Record Booklets .....	190		
Stanley and Tescher Hypnograph .....	S, 13		
Stenquist's Manuals .....	183		
Stenquist's Mechanical Assembling Tests ..183, 185			
Stenquist's Mechanical Intelligence Tests.....183			
Stenquist's Scoring Blanks.....183, 185, 190			
Sten's Variators .....	31		
Stevens' Metronome Attachment .....	71		
Stevens' Rossolimo Record Blanks.....174, 191			
Stevens' Rossolimo Test .....	174		
Stevens' Stenopaic Lens .....	12		
Stilling's Color Perception Test .....	18		
Stinchfield's "Handy-Pack" Speech Test.....S, 11			
Stinchfield's Speech Measurements .....	44		
Stoelting Co. Cardio-Pneumo Polygraph ..S, 22, 23			
Stoelting Co. Chronoscope .....	S, 15, 16		
Stoelting Co. Electric Timer and Counter.....S, 20			
Streets' Gestalt Completion Tests Lantern			
Slides .....	S, 51		
Strong's Learning Tests .....	140		
Strong's Mirror-Drawing Test .....	142		
Strong's Retention Test .....	152		
Strong's Tally Sheet .....	140		
Strong and Bernreuter Tabulator.....S, 1			
Stroop's Interference Materials.....S, 23, 24			
Strumpell and Jakobs Neurological Charts.....195			
Stutsman's Circle Copying Tests .....	S, 37		
Stutsman's Color Naming Test .....	16		
Stutsman's Colored Cubes .....	168		
Stutsman's Cross Copying Test .....	S, 37		
Stutsman's Language Test .....	124		
Tait's Labyrinth .....	134		
Taylor's Recognition Test .....	152		
Terman or Stanford Abbreviated Record Card...190			
Terman or Stanford Binet and Simon			
Discrimination of Forms Test .....	164		
Terman or Stanford Binet and Simon			
Measuring Scale for Intelligence.....174, 175			
Terman or Stanford Binet and Simon			
Test Cards and Pictures.....174			
Terman or Stanford Binet and Simon			
Unfinished Pictures Test .....	165		
Terman or Stanford Boxes .....	157		
Terman or Stanford Cognizing Test .....	153		
Terman or Stanford Fables Test .....	157		
Terman or Stanford Record Booklets .....	190		
Terman and Merrill Rev. Stanford-Binet Scales S, 41			
Terman and Merrill Rev. Stanford-Binet Scales			
Recording Booklets and Forms .....	S, 41		
Thomas' Fine Adjustment Clamp.....101			
Thompson's Personal History Record.....S, 32			
Thorndike's Handwriting Scale.....178			
Thorndike and McCall Silent Reading Test.....180			
Thurstone's Data Sheet .....	1		
Thurstone's Error Checking Test .....	165		
Thurstone's Instructions .....	1		
Thurstone's Intelligence Tests .....	174, 175, 181		
Thurstone's Manuals .....	174, 175		
Thurstone's Proverbs Test .....	164, 181		
Thurstone's Psychological Examinations.....174, 175			
Thurstone's Spatial Relation Tests .....	124		
Thurstone's Substitution Test .....	139		
Thurstone's Syllogism Tests .....	166		
Thurstone's Wheels Test .....	157		
Tiffin's Motion Picture Film.....S, 54			
Tinker's After-Image Chart .....	S, 6		
Tinker's Apprehension Test .....	134		
Tinker's Association Test .....	137		
Tinker's Color Cards .....	116		
Tinker's Exposure Frame .....	91		
Tinker's Musical Rating Sheet .....	191		
Tinker's Sorting Placard .....	147		
Tinker's Substitution Test .....	140		
Titchener's Adaptation Frame .....	27		
Titchener's After-Image Frame .....	20		
Titchener's Auditory Chart .....	195		
Titchener's Automatograph .....	64		
Titchener's Campimeter .....	18		
Titchener's Contrast Frame .....	26		
Titchener's Cylindrical Weights .....	50		
Titchener's Demonstration Color Mixer.....21, 22			
Titchener's Demonstration Kymograph .....	105		
Titchener's Demonstration Tachistoscope .....	97		
Titchener's Finger Dynamometer .....	55		
Titchener's Galton Bar .....	163		
Titchener's Horopter Model .....	194, 195		
Titchener's Kymograph Attachment .....	103		
Titchener's Metronome Box .....	71		
Titchener's Negative After-Image Apparatus.....19			
Titchener's Photograph of Monitor "Lehigh".....157			
Titchener's Pressure and Pain Points.....50			
Titchener's Protractor .....	3		
Titchener's Puzzle Pictures .....	156		
Titchener's Puzzle Pictures—Lantern Slides...S, 51			
Titchener's Rotation and Tilt Table .....	68		
Titchener's Sound Cage or Perimeter.....35, 36			
Titchener's Stereograms .....	14		
Titchener's Stereo-telestere-psuedoscope .....	13		
Titchener's Stimulus and Test Cards.....91			
Titchener's Taste Stimuli .....	42		
Titchener's Weights .....	52		
Titchener's Weighted Envelopes .....	52		
Tjaden's Analytical Interview .....	120		
Town's Manual .....	172		
Town's Picture Game Test .....	172		

Town's Picture Memory Test .....	153
Trabue's Completion Tests .....	158, 159
Trabue's Manual .....	159
Tramond's Head Charts .....	S, 50
Tscherning's Photometrical Glasses .....	S, 8
Tuttle's Directions .....	S, 32
Tuttle's Honesty Test .....	S, 32
Tuttle's Support for Long Paper Fixing .....	S, 20, 21
Twitmyer's Differential Color Mixer .....	22
Tycos Sphygmomanometers .....	211

## U

Uhrbrock's Graduate Student Rating Scale .....	S, 32
U. S. Army Alpha Test .....	176, 177
U. S. Army Beta Blackboard .....	195, 196
U. S. Army Beta Test .....	177
U. S. Army Cube Construction Test .....	161
U. S. Army Digit—Symbol Test .....	140
U. S. Army Visual Memory Test .....	154, S, 41
University of Chicago Memory Drum .....	S, 17
University of Minnesota Record Blanks .....	190
University of Southern California Motion Picture Films .....	S, 53

## V

Valentines Simplified Barany Chair .....	S, 14
Valentine's Sorting and Dealing Placard .....	S, 37
Veeder-Root Electric Counter .....	107
Veeder-Root Hand Tally Counter .....	106
Verdin's Pneumograph .....	212-213
Verhoeff's Astigmatic Chart .....	9
Vierordt's Lever .....	108
Vineland Adaptation Board .....	163, S, 38
Vineland Needle Threading Test .....	57
Vineland Porteus Maze Tests .....	173
Vineland Slide Rule .....	2
Vineland Winking Glass .....	65
Volkmann's Sound Pendulum .....	37
Von Frey's Aesthesiometer .....	47
Von Frey's Linen Gauge .....	49
Von Frey's Sphygmograph .....	211

## W

Wallin's After-Image Cards .....	20
Wallin's Association Tests .....	136, 139
Wallin's Attainment Scale for Clinical Use .....	S, 42
Wallin's Educational Records .....	S, 49
Wallin's Home Conditions and Family History Blanks .....	S, 49
Wallin's Immediate Memory Test .....	151
Wallin's Improvement Tests .....	175
Wallin's Individual Mental Examination .....	S, 49
Wallin's Peg Boards .....	57, S, 41
Wallin's Perception Test .....	123
Wallin's Physical Examination of Pupil Recommended for Examination .....	S, 49
Wallin's Record Blanks .....	S, 42, 49
Wallin's Report of Examination .....	S, 49
Wallin's Sentence Building Test .....	159
Wallin's Word Construction Test .....	159
Walter's Posturometer .....	4
Walton's Rubber Stamp .....	50
Wang's Self-Appraisal Schedule (Persistence Test) .....	S, 32
Wannemaker's Recreational Interviews .....	S, 42
Wardner's Knowledge of Tools Test .....	184
Warren and Carmichael Brightness and Saturation Disks .....	S, 6
Watson's Conditioning Apparatus .....	68
Watson's Manual .....	120
Watson's Motion Picture Film .....	S, 54
Watson's Public Opinion Test .....	119
Watson's Public Opinion Scoring Sheets .....	S, 49
Weber's Law Disks .....	27
Weber's Stereograms .....	S, 4, 5
Wechsler's Liquid Finger Electrodes .....	116
Wechsler's Psychogalvanograph .....	115
Weidensall's Association Test .....	136
Weidensall's Immediate Memory Test .....	151
Weidensall's Memory Test .....	153
Weidensall's Scoring Card .....	153
Weidensall's Spool-Packing Test .....	145
Weidensall's Verbal Directions Tests .....	134
Weinland's Tachistoscope .....	S, 18
Weiss' Circular Slide Rule .....	2
Wellman's Tracing Board .....	60
Wellman's Tracing Path .....	59

Wells' Electric Mirror-Drawing Test .....	143
Wells' Stereograms .....	14
Wenzel's Anatomical Charts .....	195
Wessell and Carmichael Motion Picture Film .....	S, 53
West's Armamentarium .....	220
West's Articulation Test .....	45
West's File Card .....	45
West's Record Blanks .....	190
West's Record Forms .....	45
West's Stencils .....	117
Weston's Foot-Candle Meter .....	S, 8
Wheatstone's Bridge .....	116
Wheatstone's Stereoscope .....	13
Whipple's Association Tests .....	136-138
Whipple's Description Test .....	134
Whipple's Discrimination of Brightness Apparatus .....	28
Whipple's Discrimination of Gray Apparatus .....	28
Whipple's Disk Tachistoscope .....	95
Whipple's Fable Chart .....	157
Whipple's Form Board Record Sheets .....	129
Whipple's Gasometer .....	34
Whipple's Immediate Memory Tests .....	151
Whipple's Linguistic Test .....	159
Whipple's Logical Memory Tests .....	153
Whipple's Mirror-Drawing Apparatus .....	143
Whipple's Mirror-Drawing Tests .....	142, 143
Whipple's Portable Tachistoscope .....	94
Whipple's Pressure and Pain Balance .....	54
Whipple's Range of Information Test .....	178
Whipple's Reading Test .....	124
Whipple's Recording Blank .....	138, 151
Whipple's Report or "Aussage" Test .....	134
Whipple's Sentence Memory Test .....	152
Whipple's Stimulus Cards .....	134
Whipple's Stop Clock .....	80
Whipple's Substitution Tests .....	139
Whipple's Suggestion Weights .....	155
Whipple's Tapping Board .....	63
Whipple's Target Test .....	58, 59
Whipple's Terman and Child Vocabulary Test .....	178
Whipple's Tracing Board .....	60
Whipple's Warmth Tester .....	155
Whipple's Word Building Test .....	159
Whipple and Gilbert Suggestion Weights .....	155
Whitley's Form Recognition Test .....	152
Whitley's Mazes .....	50, 61
Whitley's Perception Tests .....	124
Whitley's Speed and Accuracy Test .....	60
Whitman's Manual Dexterity Test .....	159
Williams' Humorous Cartoons .....	116
Wilson's Ethical Discrimination Test .....	164
Wilson's Letters and Figures .....	96
Wilson's Manual .....	165
Wilson's Religious Aptitude Test .....	S, 42
Winch's Sentence Test .....	159
Witmer's Cylinder Test .....	163
Witmer's Seguin Form Board .....	129
Woods' (L.), Picture Completion Test .....	S, 38
Wood's Pseudoscope .....	15
Woodworth's Personal Data Sheet .....	118, S, 31
Woodworth and Cady Personal Data Sheet .....	S, 31
Woodworth and House Mental Hygiene Inventories .....	120
Woodworth and Mathews Personal Data Sheet .....	118
Woodworth and Richmond Personal Data Sheet .....	118
Woodworth and Wells Association Tests .....	136-139, 176
Woodworth and Wells Color Naming Test .....	16
Woodworth and Wells Directions Tests .....	133
Woodworth and Wells Record Blanks .....	190
Woodworth and Wells Substitution Test .....	140
Woolley's Association Test .....	138
Woolley's Construction Puzzle Test .....	161
Woolley's Identification of Forms Test .....	164
Woolley and Fischer Association Test .....	136
Woolley and Fischer Immediate Memory Test .....	151
Woolley and Fischer Linguistic Tests .....	159
Woolley and Fischer Mental and Physical Tests .....	176
Woolley and Fischer Sorting Test .....	61
Woolley and Fischer Substitution Test .....	139
Worcester Form Boards .....	175, 176
Wundt's Complication Pendulum .....	165
Wundt's Control Hammers .....	77
Wundt's Course of a Sense Feeling Model .....	194
Wundt's Negative After-Image Apparatus .....	20
Wundt's Sound Hammer .....	37

## Y

Yale Psycho-Clinic Developmental Schedules.....	191	Yerkes, Bridges and Hardwick, Binet and Simon Sentence Test .....	159
Yepsen's Slide Rule .....	2	Yerkes and Foster Adolescent-Adult Record Blanks .....	191
Yerkes' Binet Simon Visual Memory Tests.....	154	Yerkes and Foster Card Test .....	133
Yerkes' Code Test .....	140	Yerkes and Foster Cognizing Test .....	153
Yerkes' Multiple Choice Apparatus.....	149, S, 37	Yerkes and Foster Point Scale .....	176
Yerkes' Relational Test .....	124	Yerkes and Foster Reproduction Test .....	S, 37
Yerkes' Visual Memory Test .....	154	Yerkes and Foster Visual Memory Test .....	154
Yerkes, Bridges and Hardwick, Binet and Simon Aesthetic Judgment Test .....	166	Young's (H.), Age Calculator .....	2
Yerkes, Bridges and Hardwick, Binet and Simon Line Suggestion Test .....	154	Young's (P. T.), Difference-Tone Bars .....	32
Yerkes, Bridges and Hardwick, Binet and Simon Unfinished Pictures Test .....	165	Young's (H.), Ororreflector .....	S, 59
Yerkes, Bridges and Hardwick, Binet and Simon Line Comparison Test .....	162	Young's (P. T.), Pseudophone .....	S, 10
Yerkes, Bridges and Hardwick, Binet and Simon Point Scales .....	176	Young's (H.), Slot Mazes .....	125, 126, S, 34
Yerkes, Bridges and Hardwick, Binet and Simon Record Blanks .....	191	Young's (P. T.) Tunable Bars .....	32
		Yourievitch's Goggles .....	99
		Yourievitch's Ocular Mask .....	99
		<b>Z</b>	
		Zeiss' Stereoscope .....	13
		Zwaardemaker's Olfactometers .....	40

## SUPPLEMENTARY CATALOG INDEX

<b>A</b>			
Abbreviations, Key .....	55	Board, Peg .....	41
A-B-C Vision Test .....	3	Board, Adaptation .....	38
Accessories, Kymograph .....	19	Book Stereoscope .....	4
Accessories, Miscellaneous .....	33, 34	Booklets, Record .....	41
Accessories, Photopolygraph .....	29	Books .....	56, 57
Accessories, Polygraph .....	21, 23	Box, Instruction or Motivation .....	36
Accessories, Telebinocular .....	4	Box, Obstruction or Motivation .....	37
Adaptation Board .....	38	Box, Problem .....	35
Aesthesiometer Rack .....	11	Boxes, Color Projection .....	6
After-Image Apparatus .....	6	Breathing Apparatus.....	58, 59
After-Image Chart .....	6	Brightness and Saturation Disks .....	6
Algesimeter .....	12	Brightness Discrimination Device .....	8
Analysis of Reasoning Apparatus .....	38	Brightness Disk .....	8
Anatomical Stereograms .....	4	<b>C</b>	
Annoyance Test .....	32	Caliper .....	1
Apparatus, After-Image .....	6	Card Changer, Electrically Operated .....	17
Apparatus, Analysis of Reasoning .....	38	Card Changer, Manually Operated .....	16
Apparatus, Breathing .....	58, 59	Cardio-Pneumo Polygraph .....	22, 23
Apparatus, Circulation .....	59	Cards, Stimulus .....	36
Apparatus, Depth Perception .....	7, 8	Cards, Color Preference .....	38
Apparatus, Exposure .....	16, 17, 18	Cards, Drawing .....	4
Apparatus, Finger Dexterity .....	47	Cards, Exposure .....	17
Apparatus, Hypnotic .....	37	Cards, Peripheral Vision .....	6
Apparatus, Knee-Jerk .....	13	Cards, Record .....	18, 44
Apparatus, Mirror-Tracing .....	36	Cartridges .....	33
Apparatus, Multiple Choice .....	37	Cathode Ray Oscillograph .....	10
Apparatus, Noise .....	14	Chairs, Barany .....	14
Apparatus, Phi-Phenomena .....	35	Chairs, Child's .....	40
Apparatus, Pursuit .....	13	Chairs, Rotating .....	14
Apparatus, Respiration .....	59	Chart, After-Image .....	6
Apparatus, Tweezer Dexterity .....	47	Chart, Correlation .....	1
Arithmetical Test .....	43	Chart, Psychoanalytical .....	33
Arm Bandage, Inflatable .....	23, 29	Charts, Head .....	50
Arterial Elasticity Model .....	49, 50	Charts, Perimeter .....	6
Assembly Test, Girls .....	44	Chronoscopes .....	14, 15, 16
Ataxiagraph .....	13	Circulation Apparatus .....	59
Ataxiometer .....	13	Clamp, Right Angle .....	34
Attainment Scale, Clinical .....	42	Clamp, Table .....	34
Audiometer, Musical Touch .....	10	Clerical Test .....	46
Authors' Index .....	60, 68	Color Disks .....	33
<b>B</b>		Color Mass Discrimination Test .....	38
Bag, Ear Douche .....	14	Color Mixers .....	6, 7
Balanced Relay .....	34	Color Mixer, Binocular .....	7
Bandage Inflatable Arm .....	23, 29	Color Perception Tests .....	5, 6
Barany Chairs .....	14	Color Preference Cards .....	38
Beeswax, Yellow .....	9	Color Projection Boxes .....	6
Behavior Research Photopolygraph .....	26, 27, 28, 29	Commutator .....	59
Binocular Color Mixer .....	7	Comprehension Test .....	41
Black Velvet Paper .....	7	Converter, Rotary .....	34
Blank, Occupational Inventory .....	42	Convertible Stereograms .....	4
Blanks, Record 11, 37, 39, 40, 41, 42, 44, 46, 48, 49		Convertible Stereoscope .....	4
Blindfolds .....	29, 37	Copying Tests .....	37
Block, Wiggly .....	43	Correlation Chart .....	1
Blueprint Reading Test .....	44	Cross, Fixation .....	6
		Cross Section Precision Stamp, Rubber .....	11
		Cube Imitation Test .....	41
		Current Regulator .....	25
		Cut-off .....	14
		Cylinder Board, Primary .....	38
		<b>D</b>	
		Dart Test .....	13
		Data Sheets, Personal .....	31
		Daylight Lamp .....	33
		Demonstration Maze Board .....	37
		Depth Perception Apparatus .....	7, 8
		Developmental Age Test .....	32
		Diagnostic Reading Examination .....	11
		Directions .....	32
		Discrimination Device, Brightness .....	8
		Discrimination Weights .....	12
		Disk, Brightness .....	8
		Disk, Shade .....	8
		Disk, Stroboscopic Timing .....	16
		Disk Test .....	39
		Disk-Spinner .....	33
		Disk, Tint .....	8
		Disks, Brightness and Saturation .....	6
		Disks, Color .....	33
		Drawing Cards .....	4
		Drum, Memory .....	17
		Duplex Electric Recorder .....	19
		Dynamometers .....	12
		Dynamometer and Dynamograph, Finger .....	12
		<b>E</b>	
		Ear Douche Bag .....	14
		Educational Information Test .....	43, 49
		Electric Circuit Tracing Test .....	45
		Electric Color Mixers .....	6, 7
		Electric Recorder, Duplex .....	19
		Electric Timer and Counter .....	20, 21
		Electrically Operated Card Changer .....	17
		Electrodes .....	29, 30
		Electrola, Phonograph .....	45, 46
		Engine-Lathe Test Blank .....	48
		Examination, Individual, Mental .....	49
		Examination, Individual, Physical, Pupil .....	49
		Examination, Individual, Report .....	49
		Exposure Apparatus .....	16, 17, 18
		Exposure Cards .....	17
		<b>F</b>	
		Facial Model, Full Face .....	31

- Falling Door Tachistoscope... 18  
 Figures ..... 36  
 Film Projector ..... 33, 34  
 Films, Motion Picture. 51, 52, 53, 54  
 Finger Dexterity Apparatus .. 47  
 Finger Dynamometer and  
 Dynamograph ..... 12  
 Finger Plethysmograph ..... 23, 58  
 First-Year Mental Scale..... 40  
 Fixation Cross ..... 6  
 Fixing Bath Support..... 20, 21  
 Foot Candle Photometers..... 8  
 Forks, Tuning ..... 9  
 Form Boards ..... 35, 36, 39, 40, 41  
 Form Board Paper ..... 46  
 Form-Constancy Stereograms. 5
- G**  
 Gauge, Limen ..... 11  
 Geissler Tube ..... 34  
 General Information Score  
 Sheet ..... 42  
 Glasses, Photometrical ..... 8  
 Glazed Kymograph Paper..... 20  
 Goggle Receiving Tambour..... 19  
 Gray Paper ..... 7  
 Grease Pencils ..... 34  
 Guide, Personality Index and  
 Success ..... 32  
 Guilt Stimuli ..... 36
- H**  
 Habit Interference Test..... 13  
 Handy-Pack Speech Tests..... 11  
 Head Charts ..... 50  
 History, Home Conditions,  
 Personal and Family..... 49  
 Honesty Test ..... 32  
 Hooded Screen ..... 33  
 Hypnograph ..... 13  
 Hypnotic Apparatus ..... 37
- I**  
 I.E.R. Test, Revised..... 44  
 Immediate Memory Test..... 37  
 Incandescent Lamps ..... 4, 10, 29  
 Index, Authors' ..... 60, 68  
 Individual Mental Examination  
 49  
 Inflatable Arm Bandage..... 23, 29  
 Ink-Blot Test ..... 31  
 Instruction Box ..... 36  
 Instructions ..... 43, 44  
 Intelligence Test ..... 41  
 Interest Blank, Occupational... 43  
 Interference Materials ..... 23, 24  
 Interviews, Recreational ..... 42  
 Introversion-Extroversion  
 Tests ..... 32, 33  
 Inventory, Occupational ..... 42  
 Inventory, Personality ..... 31, 32, 33
- K**  
 Key, Abbreviations ..... 55  
 Key, Make ..... 24  
 Keys, Reaction ..... 11, 29  
 Keys, Voice ..... 11, 29  
 Knee-Jerk Apparatus ..... 13  
 Kymograph ..... 19  
 Kymograph Accessories ..... 19, 20  
 Kymograph Paper, Glazed ..... 20  
 Kymograph Paper, Waxed ..... 20
- L**  
 Laboratory Polygraph ..... 21, 22  
 Laboratory Stop Watches ..... 14  
 Lamp, Daylight ..... 33  
 Lamps, Incandescent ..... 4, 10, 29  
 Lantern Slides ..... 50, 51  
 Library Paste ..... 5  
 Limen Gauge ..... 11
- M**  
 Make Key ..... 24  
 Manometer, Mercury ..... 58  
 Manual Ability Task ..... 43, 44  
 Manuals ..... 4, 11, 24, 31,  
 32, 33, 39, 40, 41, 42, 43, 44, 46, 48
- Manoptometer ..... 3  
 Materials, Interference ..... 23, 24  
 Maxim Test ..... 38  
 Maze Board, Demonstration .. 37  
 Maze C, Slot ..... 34  
 Mechanical Ability Test..... 43, 44  
 Memory Drum ..... 17  
 Memory Tests ..... 41  
 Mental Deterioration Test..... 41  
 Mercury Manometer ..... 58  
 Metascope and Diploscope... 2, 3  
 Meters, Pursuit ..... 13  
 Metron-O-Scope Record Charts 18  
 Metron-O-Scope Rolls ..... 18  
 Metron-O-Scopes ..... 17  
 Micrometer Reading Test..... 45  
 Mirror-Tracing Apparatus ..... 36  
 Mirror-Tracing Tests ..... 36  
 Miscellaneous Accessories... 33, 34  
 Model, Arterial Elasticity... 49, 50  
 Model Facial, Full Face..... 31  
 Motion Picture Films. 51, 52, 53, 54  
 Motivation Apparatus,  
 Columbia ..... 37  
 Multiple Choice Apparatus... 37  
 Multiple Choice Reaction  
 Test ..... 47, 48  
 Muscle Warmer ..... 59  
 Musical Discrimination Test... 46  
 Musical Tonus Audiometer... 10
- N**  
 Noise Apparatus ..... 14  
 Nonpolarizing Electrodes ... 29, 30  
 Nonsense Syllables ..... 36
- O**  
 Obstruction Box, Columbia... 37  
 Occupational Interest Blank... 43  
 Occupational Inventory ..... 42  
 One-way Screen ..... 5  
 Opaque Projector ..... 33  
 Ophthalm-O-Graph Record  
 Cards ..... 18  
 Ophthalm-O-Graphs ..... 18  
 Ophthalmometer ..... 2  
 Oreflector ..... 59  
 Oscillograph ..... 10
- P**  
 Paper, Black Velvet ..... 7  
 Paper, Form Boards ..... 46  
 Paper, Gray ..... 7  
 Paper, Kymograph ..... 20  
 Paper, Recording ..... 21  
 Paper, Waxed Surface ..... 20  
 Passalong Test ..... 39  
 Paste, Library ..... 5  
 Peg Board ..... 41  
 Pelvimeter ..... 1  
 Pencils, Grease ..... 34  
 Pendulum Pursuit Meter..... 13  
 Performance Scales ..... 41  
 Performance Tests ..... 41  
 Perimeters ..... 6  
 Perimeter Charts ..... 6  
 Peripheral Vision Cards..... 6  
 Personal Data Sheets ..... 31  
 Personal History Record ..... 32  
 Personal Traits Rating Scales 33  
 Personality Chart,  
 Psychoanalytical ..... 33  
 Personality Index and Success  
 Guide ..... 32  
 Personality Inventory... 31, 32, 33  
 Personnel Questionnaire ..... 32  
 Phakoscope ..... 2  
 Phi-Phenomena Apparatus ... 35  
 Phonetic Discrimination Test... 46  
 Phonograph ..... 45, 46  
 Phonograph Records... 37, 45, 46  
 Phono-Projectoscope ..... 10  
 Photographic Shutter ..... 33  
 Photographs ..... 38, 50  
 Photometers ..... 8
- Photometrical Glasses ..... 8  
 Photopolygraph, Behavior  
 Research..... 26, 27, 28, 29  
 Photopolygraph Accessories .. 29  
 Physical Examination, Pupil.. 49  
 Piano Wire ..... 50  
 Pictorial Completion Tests... 38  
 Pictures Tests, Social Situation 33  
 Pistol, Target ..... 33  
 Placard, Sorting and Dealing.. 37  
 Plastographs ..... 5  
 Plethysmographs ..... 23, 58  
 Pneumographs ..... 23, 29, 58  
 Pole Changer ..... 59  
 Polygraphs ..... 21, 22, 23  
 Polygraph Accessories..... 21, 23  
 Portraits ..... 50  
 Positive After-Image Apparatus 6  
 Precision Cross Section Stamp. 6  
 Preschool Children's Tests... 39, 41  
 Primary Cylindrical Board... 38  
 Problem Box ..... 35  
 Projector, Film ..... 33, 34  
 Projector, Opaque ..... 33  
 Pseudophone ..... 10  
 Psychoanalytical Personality  
 Chart ..... 33  
 Psychiatric Record Blank.... 49  
 Psychodiagnostik Test ..... 31  
 Psychodimeters ..... 24, 25  
 Psychogalvanoscope ..... 25, 26  
 Psychotic Questionnaire ..... 32  
 Purposive Thinking Test ..... 38  
 Pursuit Apparatus ..... 13  
 Pursuit Meters ..... 13  
 Pursuit Meter, Pendulum ..... 13  
 Puzzles ..... 35, 36, 37  
 Pyramid, Truncated ..... 5
- Q**  
 Questionnaire, Personnel ..... 32  
 Questionnaire, Psychotic ..... 32
- R**  
 Rack, Aesthesiometer ..... 11  
 Rack, Weight ..... 12  
 Racket-Paddle ..... 37  
 Rating Scale ..... 32  
 Rating Sheet ..... 11  
 Reaction Keys ..... 11, 29  
 Reading Examination,  
 Diagnostic ..... 11  
 Reading Span Test..... 18  
 Receiving Tambour, Goggle... 19  
 Recognition Test ..... 37  
 Record Blanks .....  
 11, 37, 39, 40, 41, 42, 44, 46, 48, 49  
 Record Booklets ..... 41  
 Record, Educational ..... 49  
 Record, Personal History..... 32  
 Records, Phonograph... 37, 45, 46  
 Recorder, Duplex, Electric... 19  
 Recording, Paper, Ink ..... 21, 23  
 Recording, Paper, Waxed ..... 20  
 Recording, Tambour ..... 19  
 Recreational Interviews ..... 42  
 Rectifiers, Dry Metallic..... 34  
 Reference Books ..... 56, 57  
 Reflexohmeter ..... 29, 30  
 Regulator, Current ..... 25  
 Relay, Balanced ..... 34  
 Relay, "Pony" ..... 34  
 Relay, Voice Key ..... 11  
 Religious Aptitude Tests... 42  
 Report, Examination ..... 49  
 Reproduction Test ..... 37  
 Respiration Apparatus ..... 59  
 Restlessness or Motility  
 Recorder ..... 13  
 Rheostat ..... 7  
 Right Angle Clamp..... 34  
 Rocker ..... 8  
 Rocker Puzzle ..... 37  
 Rod, Support ..... 19  
 Rolls, Metron-O-Scope ..... 18



Rotary Converter .....	34	Supports.....	20, 21, 58	Test, Star-Drawing .....	36
Rotating Chair .....	14	Support Rod .....	19	Test, Substitution .....	41
Rubber Stamp .....	11			Test, Tact .....	32
				Test, Teachers' Judgment in Child Discipline .....	48
				Test, Teachers' Professional Judgment .....	48
<b>S</b>		<b>T</b>		Test, Visual Acuity .....	1, 2, 3
Scale, Attainment, Clinical ...	42	Table Clamp .....	34	Test, Vocational Information..	43
Scale, First Year Mental.....	40	Table Standard .....	40	Test, Color Perception .....	5, 6
Scale, Measuring, Social		Tabulator, Plus and Minus....	1	Test, Copying .....	37
Adequacy .....	33	Tachistoscopes .....	13	Test, Introversion-	
Scale, Rating .....	32	Tact Test .....	32	Extroversion .....	32, 33
Scale, Rating, Personal Traits.	33	Tambour, Goggle, Receiving...	19	Test, Mirror-Tracing .....	36
Scale, Self-Measuring .....	43	Tambour, Recording .....	19	Test, Performance .....	41
Scales, Performance .....	41	Target .....	14	Test, Pictorial Completion ...	38
Scales, Stanford-Binet .....	41	Target Pistol .....	33	Test, Preschool Children's ..	39, 41
Schedule, Self-Appraisal .....	32	Task, Manual Ability.....	43, 44	Test, Religious Aptitude .....	42
Scissors .....	41	Teachers' Judgment in Child Discipline Test .....	48	Test, Speech .....	11
Scoring Blanks .....	40	Teachers' Professional Judgment Test .....	48	Test, Social Situation Pictures	33
Scoring Sheets.....	5, 11, 42, 46, 49	Telebinocular .....	3, 4	Test, Visual Memory ...	36, 37, 41
Screen, Hooded .....	33	Telebinocular Accessories .....	4	T-F-L Puzzles .....	36
Screen, One-way .....	5	Telegraph Snapper .....	40	Timer and Counter, Electric.	20, 21
Self-Appraisal Schedule .....	32	Test, Annoyance .....	32	Timing Disk, Stroboscopic....	16
Self-Measuring Scale .....	43	Test, Arithmetical .....	43	Tint Disk .....	8
Shade Disk .....	8	Test, Assembly, for Girls....	44	Tonoscope .....	10
Sheet, Rating .....	11	Test, Blueprint Reading .....	44	Transformer, Adjustable Toy..	20
Shutter, Photographic .....	33	Test, Clerical .....	46	Tremographs .....	29
Size-Constancy Stereograms...	4	Test, Color Mass Discrimination .....	38	Truncated Pyramid .....	5
Sleep Recorder .....	13	Test, Comprehension .....	41	Tube, Geissler .....	34
Slides, Lantern .....	50, 51	Test, Cube Imitation .....	41	Tube, Y .....	34
Slot Maze C .....	34	Test, Dart .....	13	Tuning Forks .....	9
Snapper, Telegraph .....	40	Test, Development Age.....	32	Tweezer Dexterity Apparatus..	47
Social Adequacy Measuring Scale .....	33	Test, Disk .....	39		
Social Situation Pictures		Test, Educational Information .....	43, 49	<b>U</b>	
Tests .....	33	Test, Electric Circuit Tracing.	45	Universal Electrodes .....	30
Song Whistle .....	9	Test, Engine-Lathe Blank ...	48		
Sorting and Dealing Placard...	37	Test, Habit Interference .....	13	<b>V</b>	
Sound Effects and Elimination of Overtones .....	45	Test, Handy-Pack .....	11	Velvet Paper, Black.....	7
Speech Tests .....	11	Test, Honesty .....	32	Vision Cards, Peripheral.....	6
Spinner, Disk .....	33	Test, I.E.R., Revised .....	44	Vision Test, A-B-C.....	3
Spot Pattern Test.....	36	Test, Immediate Memory .....	37	Visual Acuity Test .....	1, 2, 3
Stamp, Rubber .....	11	Test, Ink-Blot .....	31	Visual Memory Test .....	36, 37
Stanford-Binet Scale .....	41	Test, Intelligence .....	41	Vocational Information Test..	43
Star-Drawing Test .....	36	Test, Maxim .....	38	Voice Keys .....	11, 29
Stencils .....	33, 46, 49	Test, Mechanical Ability....	43, 44	Voice Key Relay .....	11
Stereograms .....	4, 5	Test, Mental Deterioration ...	41		
Stereograms, Anatomical .....	4	Test, Micrometer Reading....	45	<b>W</b>	
Stereograms, Convertible .....	4	Test, Multiple Choice Reaction .....	47, 48	Watches, Laboratory .....	14
Stereograms, Form-Constancy..	5	Test, Musical Discrimination..	46	Watches, Stop .....	14
Stereograms, Size-Constancy..	4	Test, Passalong .....	39	Waxed Recording Paper.....	20
Stereograms, Book .....	4	Test, Phonetic Discrimination.	46	Weight Rack .....	12
Stereoscope and Telestereo- scope .....	4	Test, Psychodiagnostik .....	31	Weights, Discrimination .....	12
Stereoscope, Convertible .....	4	Test, Purposive Thinking ...	38	Whistle, Song .....	9
Stimuli, Guilt .....	36	Test, Reading Span .....	18	Wiggly Block .....	43
Stimulus Cards .....	36	Test, Recognition .....	37	Wire, Piano .....	50
Stop Watches .....	14	Test, Reproduction .....	37		
Stroboscopic Timing Disk....	16	Test, Spot Pattern .....	36	<b>Y</b>	
Substitution Test .....	41			Yellow Beeswax .....	9
				Yogi Puzzle .....	35
				Y-Tube .....	34